

# Panasonic®

## Operating Instructions

### DVD Recorder

Model No. **DMR-EZ17**

# DIGA

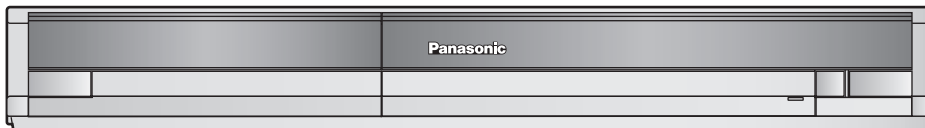

The illustrations in these Operating Instructions show images of the silver model of this unit.

### Dear customer

Thank you for purchasing this product.  
For optimum performance and safety, please read these instructions carefully.

Before connecting, operating or adjusting this product, please read the instructions completely.  
Please keep this manual for future reference.



#### Region number supported by this unit

Region numbers are allocated to DVD players and DVD-Video according to where they are sold.

- The region number of this unit is “1”.
- The unit will play DVDs marked with labels containing “1” or “ALL”.

Example:



#### If you have any questions contact

1-800-211-PANA(7262)

The warranty can be found on page 67.

La referencia rápida en español se encuentra en la página 68-71.

# Precautions

## CAUTION!

THIS PRODUCT UTILIZES A LASER.  
USE OF CONTROLS OR ADJUSTMENTS OR PERFORMANCE OF PROCEDURES OTHER THAN THOSE SPECIFIED HEREIN MAY RESULT IN HAZARDOUS RADIATION EXPOSURE.  
DO NOT OPEN COVERS AND DO NOT REPAIR YOURSELF. REFER SERVICING TO QUALIFIED PERSONNEL.

## WARNING:

TO REDUCE THE RISK OF FIRE, ELECTRIC SHOCK OR PRODUCT DAMAGE,

- DO NOT EXPOSE THIS APPARATUS TO RAIN, MOISTURE, DRIPPING OR SPLASHING AND THAT NO OBJECTS FILLED WITH LIQUIDS, SUCH AS VASES, SHALL BE PLACED ON THE APPARATUS.
- USE ONLY THE RECOMMENDED ACCESSORIES.
- DO NOT REMOVE THE COVER (OR BACK); THERE ARE NO USER SERVICEABLE PARTS INSIDE. REFER SERVICING TO QUALIFIED SERVICE PERSONNEL.

## CAUTION!

DO NOT INSTALL OR PLACE THIS UNIT IN A BOOKCASE, BUILT-IN CABINET OR IN ANOTHER CONFINED SPACE. ENSURE THE UNIT IS WELL VENTILATED. TO PREVENT RISK OF ELECTRIC SHOCK OR FIRE HAZARD DUE TO OVERHEATING, ENSURE THAT CURTAINS AND ANY OTHER MATERIALS DO NOT OBSTRUCT THE VENTILATION VENTS.



CAUTION: TO REDUCE THE RISK OF ELECTRIC SHOCK, DO NOT REMOVE SCREWS. NO USER-SERVICEABLE PARTS INSIDE. REFER SERVICING TO QUALIFIED SERVICE PERSONNEL.



The lightning flash with arrowhead symbol, within an equilateral triangle, is intended to alert the user to the presence of uninsulated "dangerous voltage" within the product's enclosure that may be of sufficient magnitude to constitute a risk of electric shock to persons.



The exclamation point within an equilateral triangle is intended to alert the user to the presence of important operating and maintenance (servicing) instructions in the literature accompanying the appliance.

## CAUTION

Danger of explosion if battery is incorrectly replaced. Replace only with the same or equivalent type recommended by the manufacturer. Dispose of used batteries according to the manufacturer's instructions.

## Note to CATV system installer:

This reminder is provided to call the CATV system installer's attention to Article 820-40 of the NEC that provides guidelines for proper grounding and, in particular, specifies that the cable ground shall be connected to the grounding system of the building, as close to the point of cable entry as practical.

The socket outlet shall be installed near the equipment and easily accessible. The mains plug of the power supply cord shall remain readily operable. To completely disconnect this apparatus from the AC Mains, disconnect the power supply cord plug from AC receptacle.

## FCC Note:

This equipment has been tested and found to comply with the limits for a Class B digital device, pursuant to Part 15 of the FCC Rules. These limits are designed to provide reasonable protection against harmful interference in a residential installation. This equipment generates, uses, and can radiate radio frequency energy and, if not installed and used in accordance with the instructions, may cause harmful interference to radio communications. However, there is no guarantee that interference will not occur in a particular installation. If this equipment does cause harmful interference to radio or television reception, which can be determined by turning the equipment off and on, the user is encouraged to try to correct the interference by one or more of the following measures:

- Reorient or relocate the receiving antenna.
- Increase the separation between the equipment and receiver.
- Connect the equipment into an outlet on a circuit different from that to which the receiver is connected.
- Consult the dealer or an experienced radio/TV technician for help.

FCC Caution: To assure continued compliance, follow the attached installation instructions and use only shielded interface cables when connecting to peripheral devices. Any changes or modifications not expressly approved by the party responsible for compliance could void the user's authority to operate this equipment.

This device complies with Part 15 of the FCC Rules. Operation is subject to the following two conditions: (1) This device may not cause harmful interference, and (2) this device must accept any interference received, including interference that may cause undesired operation.

Responsible Party:  
Panasonic Corporation of North America  
One Panasonic Way  
Secaucus, NJ 07094

Support Contact:  
Panasonic Consumer Electronics Company  
Telephone No.: 1-800-211-7262

<b>DANGER</b>	VISIBLE AND INVISIBLE LASER RADIATION WHEN OPEN. AVOID DIRECT EXPOSURE TO BEAM. FDA 21 CFR/Class IIIb
<b>CAUTION</b>	CLASS 3B VISIBLE AND INVISIBLE LASER RADIATION WHEN OPEN. AVOID EXPOSURE TO THE BEAM. IEC60825-1+A2/Class 3B
<b>ATTENTION</b>	RAYONNEMENT LASER VISIBLE ET INVISIBLE, CLASSE 3B, EN CAS D'OUVERTURE, EVITER UNE EXPOSITION AU FAISCEAU.
<b>FORSIGTIG</b>	SYNLIG OG USYNLIG LASERSTRÅLING KLASSE 3B, NÅR LAGET ER ÅBENT, UNDGÅ AT BLIVE UDSAT FOR STRÅLEN.
<b>VARO</b>	AVATTAESSA OLET ALTTIINA LUOKAN 3B NÄKYVÄÄ JA NÄKYMÄTÖNTÄ LASERSÄTEILYÄ. VARO ALTISTUMISTA SÄTEELLE.
<b>WARNING</b>	KLASS 3B SYNLIG OCH OSYNLIG LASERSTRÅLNING NÄR DENNA DEL ÄR ÖPPNAD. UNDIK EXPONERING FÖR STRÅLEN.
<b>VORSICHT</b>	SICHTBARE UND UNSICHTBARE LASERSTRAHLUNG KLASSE 3B. WENN ABDECKUNG GEÖFFNET, NICHT DEM STRAHL AUSSETZEN.
<b>注意</b>	— 打开时有可见及不可见激光辐射。避免光束照射。
<b>注意</b>	— ここを開くと可視及び不可視レーザー光が出ます。ビームを見たり、触れたりしないでください。VQL1J70

(Inside of product)

# IMPORTANT SAFETY INSTRUCTIONS

Read these operating instructions carefully before using the unit. Follow the safety instructions on the unit and the applicable safety instructions listed below. Keep these operating instructions handy for future reference.

- 1) Read these instructions.
- 2) Keep these instructions.
- 3) Heed all warnings.
- 4) Follow all instructions.
- 5) Do not use this apparatus near water.
- 6) Clean only with dry cloth.
- 7) Do not block any ventilation openings. Install in accordance with the manufacturer's instructions.
- 8) Do not install near any heat sources such as radiators, heat registers, stoves, or other apparatus (including amplifiers) that produce heat.
- 9) Do not defeat the safety purpose of the polarized or grounding-type plug. A polarized plug has two blades with one wider than the other. A grounding-type plug has two blades and a third grounding prong. The wide blade or the third prong are provided for your safety. If the provided plug does not fit into your outlet, consult an electrician for replacement of the obsolete outlet.
- 10) Protect the power cord from being walked on or pinched particularly at plugs, convenience receptacles, and the point where they exit from the apparatus.
- 11) Only use attachments/accessories specified by the manufacturer.
- 12) Use only with the cart, stand, tripod, bracket, or table specified by the manufacturer, or sold with the apparatus. When a cart is used, use caution when moving the cart/apparatus combination to avoid injury from tip-over. 
- 13) Unplug this apparatus during lightning storms or when unused for long periods of time.
- 14) Refer all servicing to qualified service personnel. Servicing is required when the apparatus has been damaged in any way, such as power-supply cord or plug is damaged, liquid has been spilled or objects have fallen into the apparatus, the apparatus has been exposed to rain or moisture, does not operate normally, or has been dropped.

## Unit Care

The precision parts in the unit are readily affected by the environment, especially temperature, humidity, and dust. Cigarette smoke also can cause malfunction or breakdown.

To clean the unit, wipe with a soft, dry cloth.

- Never use alcohol, thinner or benzene to clean the unit.
- Before using chemically treated cloth, carefully read the instructions that came with the cloth.

Observe the following points to ensure continued listening and viewing pleasure.

Dust and dirt may adhere to the unit's lens over time, possibly making it impossible to record or play discs.

Use the DVD lens cleaner about once every year, depending on frequency of use and the operating environment.

Carefully read the lens cleaner's instructions before use.

Lens cleaner: RP-CL720PP

Do not place the unit on amplifiers or equipment that may become hot. The heat can damage the unit.



Before moving the unit, ensure the disc tray is empty. Failure to do so will risk severely damaging the disc and the unit.

■ When the unit is not to be used for a long time

To save power, unplug the AC power supply cord from the household AC outlet. This unit consumes a small amount of power, even when it is turned off.

		Front Display (→ 34)	
		Automatic	Bright
Quick Start (→ 32)	On	Approx. 14 W	Approx. 14 W
	Off	Approx. 1 W	Approx. 2 W

**The manufacturer accepts no responsibility and offers no compensation for loss of recorded or edited material due to a problem with the unit or recordable media, and accepts no responsibility and offers no compensation for any subsequent damage caused by such loss.**

**Examples of causes of such losses are**

- A disc recorded and edited with this unit is played in a DVD Recorder or computer disc drive manufactured by another company.
- A disc used as described above and then played again in this unit.
- A disc recorded and edited with a DVD Recorder or computer disc drive manufactured by another company is played in this unit.

# Table of Contents, Accessories

## Getting Started

Precautions .....	2
IMPORTANT SAFETY INSTRUCTIONS .....	3
Unit Care .....	3
Accessories .....	5
Remote Control Information .....	5

## Basic Operations

Watching Television, Playback .....	6
Watching Television Program .....	6
Playing Discs .....	6
Recording Television Programs .....	7
Scheduled Recording .....	8
Deleting Recordings .....	9
Delete Navigator .....	9
Delete Recordings During Playback .....	9

Refer to page 50 for Control Reference Guide.

## Advanced Features

Important Notes for Recording .....	10
Advanced Recording .....	11
Recording Modes and Durations .....	11
When the format confirmation screen is displayed .....	12
Selecting Audio Channels to record .....	12
When removing a Recorded Disc .....	12
Specifying the Recording Time .....	13
Flexible Recording .....	13
Playing while you are recording .....	14
Advanced Scheduled Recording .....	15
To cancel a scheduled recording in progress .....	15
To release the unit from recording standby (Before recording starts) .....	15
Check, Change, or Delete Programs .....	15
Advanced Playback .....	16
Menu Screens on the TV .....	16
Selecting Recordings to Play .....	16
Search .....	16
Skip .....	16
Direct Play .....	16
Quick View (Play x1.3) .....	16
Slow-motion Play .....	17
Frame-by-Frame Viewing .....	17
Time Slip .....	17
CM Skip .....	17
Create Chapters .....	17
Changing Audio during Playback .....	17
Playing Still Pictures (JPEG), MP3 .....	18
Playing Still Pictures (JPEG) .....	18
Playing MP3s .....	19
Playing Playlists .....	20
Playlist Properties .....	20
View Chapters .....	20
Entering Text .....	21
Status Messages .....	21
Recording from an External Device .....	22
Recording from a VCR, etc. .....	22
Recording from a DV Camcorder .....	23

## Advanced Editing

Recordings-Editing .....	24
Accessing the Recording View .....	24
Editing Operations to Recordings .....	24
Chapters-Creating, Editing .....	26
Accessing the Chapter View .....	26
Chapter Operations .....	26

## Setting Menu

DVD Management .....	27
Accessing the Management Menus .....	27
Setting On-Screen Menus .....	30
Accessing the On-Screen Menus .....	30
Changing the Unit's Settings .....	32
Accessing the Setup menu .....	32
Summary of Settings .....	32
Setting the Closed Caption .....	35
Setting the Parental Rating .....	36

## Connection and Setting

Basic Connection .....	38
Connecting to a Television with Direct Cable or Antenna (No Cable Box or Satellite Receiver) .....	38
Connecting to a Television and a Cable Box .....	39
Connecting to a Television and a Satellite Receiver .....	40
Using an RF Modulator, if your Television does not have Audio/ Video Terminals .....	41
Adding a Video Cassette Recorder (VCR) .....	42
Connecting to a Television and a VCR (No Cable Box or Satellite Receiver) .....	42
Connecting to a Television, a Cable Box and a VCR .....	42
Connecting to a Television, a Satellite Receiver and a VCR .....	42
Connection Options for Improved Playback Quality .....	43
Using an S Video Cable for Better Video (S Video Cable not included) .....	43
Using Component Cables for Better Video (Component Video Cables not included) .....	43
Using an Audio Cable for Better Sound .....	43
Using an Optical Digital Audio Cable for Better Sound (Optical Digital Audio Cable not included) .....	43
Setting the Channels and Clock .....	44
Other Settings .....	46
Setting Channel Captions .....	46
Adding and Deleting Channels .....	46
Selecting Television Type .....	46
Clock Settings .....	47
Automatic Off Timer .....	47
Using the Unit's Remote Control to Operate the TV and the Set Top Box (Cable Box, Satellite Receiver, etc.) .....	48

## Reference

Control Reference Guide.....	50	General Issues: Operation .....	57
Remote Control.....	50	Playback Issues: Picture .....	58
FUNCTIONS Window.....	50	Playback Issues: Sound .....	58
Main Unit.....	51	Playback Issues: Operation.....	59
The Unit's Display .....	51	Recording Issues: Recording / Scheduled recording / External input .....	59
Disc Handling .....	52	Editing Issues: DVD.....	60
Usable Discs for Recording and Playback .....	52	Frequently Asked Questions.....	61
Play-only Discs.....	53	Setup.....	61
Discs that Cannot be Played.....	53	Discs .....	61
Inserting Discs .....	53	Recording.....	62
Disc Care .....	53	Error Messages .....	63
MP3s and Still Pictures (JPEG).....	54	On the Unit's Display.....	63
MP3 File Information.....	54	On the TV .....	64
Still Picture (JPEG) Information .....	54	Product Service.....	64
Troubleshooting Guide.....	55	Specifications .....	65
If the Antenna Connector Doesn't Match .....	55	Glossary .....	66
When Other Panasonic Products Respond to this Remote Control.....	55	Limited Warranty.....	67
To Reset This Unit.....	55	Referencia rápida en español (Spanish Quick Reference).....	68
General Issues: Power .....	56	Index.....	Back cover
General Issues: Displays.....	56		

## Accessories



Please check and identify the supplied accessories. Use numbers indicated in parentheses when asking for replacement parts. (Product numbers correct as of December 2006. These may be subject to change.)  
To order accessories, refer to "Accessory Purchases" on page 67.

1 Remote control (EUR7659T50)



2 Batteries for remote control

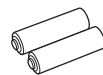

1 75  $\Omega$  coaxial cable (K2KZ2BA00001)



1 Audio/video cable (K2KA6BA00003)



1 AC power supply cord (K2CB2CB00018)

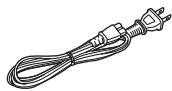

- For use with this unit only. Do not use it with other equipment. Also, do not use cords for other equipment with this unit.

### Product Registration Card

Please complete and return the included product registration card, or register via the Internet at: <http://www.prodreg.com/panasonic/>

## Remote Control Information

### About batteries

- Insert so the poles (+ and -) match those in the remote control.
- Do not use rechargeable type batteries.

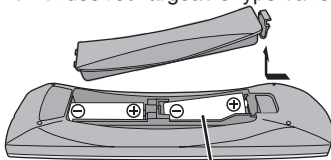

**R6/LR6, AA**

- Do not mix old and new batteries.
- Do not use different types at the same time.
- Do not heat or expose to flame.
- Do not take apart or short circuit.
- Do not attempt to recharge alkaline or manganese batteries.
- Do not use batteries if the covering has been peeled off.

Mishandling of batteries can cause electrolyte leakage which can damage items the fluid contacts and may cause a fire.

Remove if the remote control is not going to be used for a long period of time.

Store in a cool, dark place.

### Using the remote control

Aim at the sensor, avoiding obstacles, up to a maximum range of 7 m (23 feet) directly in front of the unit.

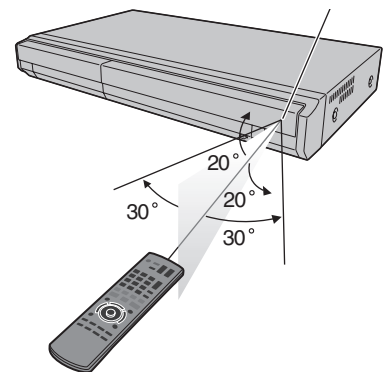

# Watching Television, Playback

## Preparation:

- Turn on the television and select the appropriate video input to suit the connections to this unit.

## Watching Television Program

This DVD recorder has a tuner which allows it to directly receive and record analog and terrestrial digital channels. High Definition (HD) programming is “down-converted” and recorded in Standard Definition (SD).

**1**  to turn the unit on.

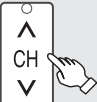
**2**  to select desired channel.

You can also select channels with the numbered buttons.

### • To directly enter channels for analog and digital broadcasts:

Antenna Mode:	Cable TV Mode:
e.g., “3”: [0] → [3] → [ENTER]	e.g., “5”: [0] → [0] → [5] → [ENTER]
“13”: [1] → [3] → [ENTER]	“15”: [0] → [1] → [5] → [ENTER]

### • To enter the sub channel number for a digital broadcast:

Antenna Mode:	Cable TV Mode:
e.g., “3-1”: [3] → [-] → [1] → [ENTER]	e.g., “1-1”: [1] → [-] → [1] → [ENTER]
“13-1”: [1] → [3] → [1] → [ENTER]	“15-1”: [1] → [5] → [-] → [1] → [ENTER]

The hyphen appears automatically on “Antenna Mode” if you enter two numbers.

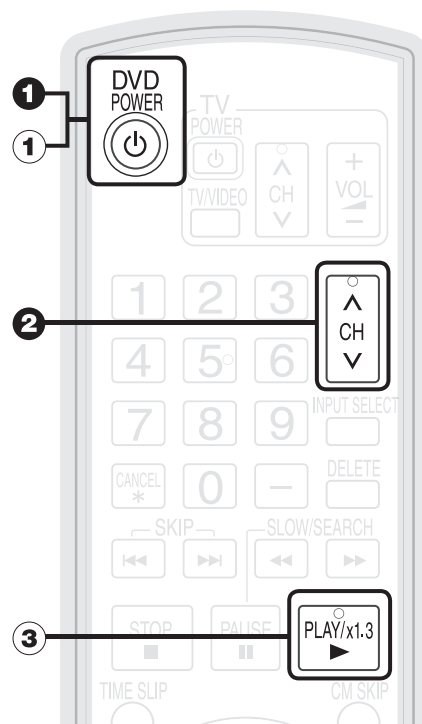

## Notes

- This unit can receive free cable television but it cannot receive paid services.
- This unit can receive music channels from digital broadcasters, but you cannot record them. Data broadcasts are not for viewing or recording.
- Multi-channel surround broadcast is output in stereo (on 2 channels).

## Playing Discs

Refer to “Advanced Playback” (→ 16 to 17) for detail information on playback.

**RAM -R -R DL -RW(V) +R +R DL +RW DVD-V -RW(VR) CD**

**1**  to turn the unit on.

**2**  to open the tray (Button located on front of the unit).  
– Insert a disc.

**3**  – The tray closes and play begins.

## Stopping Play

- Press [■ STOP].
- The stopped position is memorized.
  - The stopped position is cleared when you press [■ STOP] several times.

## Pausing Play

- Press [⏸ PAUSE].
- Press again to restart play.

## Tips

- Icons such as “**RAM**” indicate usable discs. Refer to pages 52 and 53.

## Notes

• **RAM -R -R DL -RW(V) +R +R DL +RW -RW(VR)**

Playback starts from the most recent recording.

• **DVD-V CD**

Playback starts from the beginning of the disc.

- The unit takes some time to read the disc before play starts.
- Discs continue to rotate while menus are displayed. Press [■ STOP] when you finish to preserve the unit’s motor and your television screen.

# Recording Television Programs



Refer to “Important Notes for Recording” (→ 10) and “Advanced Recording” (→ 11 to 14) for detail information on recording.

**RAM** **-R** **-R DL** **-RW(V)** **+R** **+R DL** **+RW**

## Preparation:

- Turn on the television and select the appropriate video input to suit the connections to this unit.
- **RAM** If the disc is protected, release protection (→ 27).

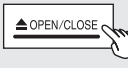
**1**  to turn the unit on.

**2**  to open the tray (Button located on front of the unit).  
 – Insert a disc with enough remaining blank space and press  again to close the tray.

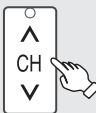
**3**  to select desired channel.

**Antenna Mode:**



**Cable TV Mode:**



- To select with the numbered buttons (→ 6)
- When no channel setting is performed on the unit and broadcast is recorded directly from the cable box or satellite receiver, select a channel on the connected equipment and press [INPUT SELECT] to select “IN1” or “IN2”.

**4**  to select the recording mode.

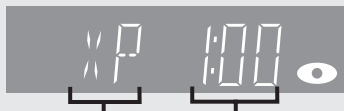

Recording mode (→ 11)    Remaining time

**5**  to start recording.



## Pausing Recording

Press [ PAUSE].  
 – Press again to restart recording.

## Stopping Recording

Press [ STOP].

## Notes

- **-R** **-R DL** **-RW(V)** **+R** **+R DL** **+RW** It takes about 30 seconds for the unit to complete recording management information after recording finishes.
- You cannot change the channel or recording mode during recording.

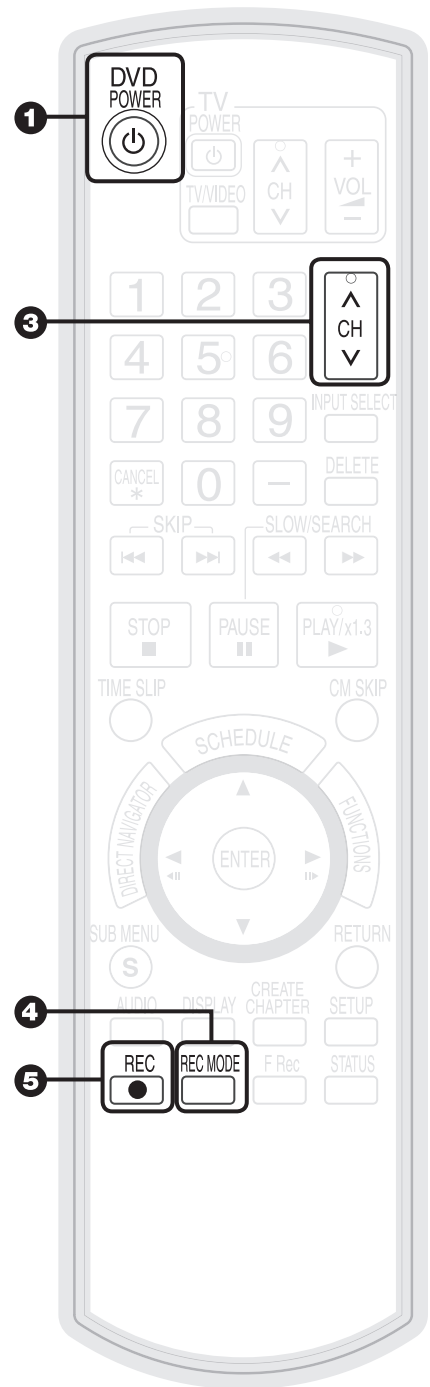

## Tips

- Icons such as “**RAM**” indicate usable discs. Refer to pages 52 and 53.

# Scheduled Recording

Refer to “Advanced Scheduled Recording” (→ 15) for detail information on scheduled recording.

**RAM** -R -R DL -RW(V) +R +R DL +RW

## Preparation:

- Turn on the television and select the appropriate video input to suit the connections to this unit.
- **RAM** If the disc is protected, release protection (→ 27).
- Insert a disc with enough remaining blank space.
- Confirm that the clock on the unit's display is set to the correct time.
- If connected via a cable box or satellite receiver, set channel there before scheduled recording starts.

**1** SCHEDULE

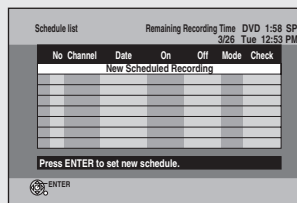

**2** ▲, ▼ to select “New Scheduled Recording”, then ENTER

**3** ◀, ▶ to move through the items and ▲, ▼ to set the items.

- Channel/Input – TV Station/External Input
- Date/Frequency – You can set a daily or weekly program.
- On (start time) / Off (end time)
  - Hold button to change in 30-minute increments.
- Mode – Recording mode
- Name – Press [ENTER], see page 21.

Channel, Caption  
Preview of selected channel

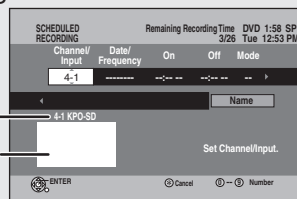

**4** ENTER

– Repeat steps 2–4 to program other recordings.

**5** DVD POWER

when you have finished programming.

– “Ⓛ” lights on the unit's display.



## Tips

- Icons such as “**RAM**” indicate usable discs. Refer to pages 52 and 53.

## Notes

- Be sure to perform step 5 before the scheduled recording time. Scheduled recording will work only if “Ⓛ” is displayed.
- “Ⓛ” flashes when the unit cannot go to scheduled recording standby. (e.g., a recordable disc is not in the disc tray) It does not flash if Quick Start is off.
- When scheduled recordings are set to start one immediately after another, the unit cannot record the beginning of the later program.
- If two scheduled recording times overlap, the first recording always has priority. The second recording will start only after the first recording has finished.
- When starting time for a scheduled recording is the same, the recording that you programmed later has priority.
- If you set DST (Daylight Saving Time) to On when manually setting the clock, scheduled recording may be affected when summer time switches to winter time and vice versa.



# Deleting Recordings

Important: Once deleted, contents cannot be recovered.

## Preparation:

- Turn on the television and select the appropriate video input to suit the connections to this unit.
- **RAM** If the disc is protected, release protection (→ 27).
- Insert a disc and press [▲ OPEN/CLOSE] again to close the tray.

## Delete Navigator

**RAM -R -R DL -RW(V) +R +R DL +RW**

With the unit stopped

1

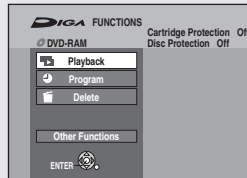

2

▲, ▼ to select "Delete"

then ENTER

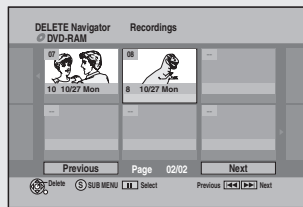

3

▲, ▼, ◀, ▶ to select the recording, then ENTER



4

◀ to select "Delete" then ENTER



## Tips

**To return to the previous screen**  
Press [RETURN].

**To view other pages**  
Press [▲, ▼, ◀, ▶] to select "Previous" or "Next" and press [ENTER].  
• You can also press [◀◀, ▶▶] to view other pages.

**Multiple editing**  
Select with [▲, ▼, ◀, ▶] and press [|| PAUSE]. (Repeat.)  
• A check mark appears. Press [|| PAUSE] again to cancel.

## Delete Recordings During Playback

**RAM -R -R DL -RW(V) +R +R DL +RW**

During playback

1



2

◀ to select "Delete" then ENTER

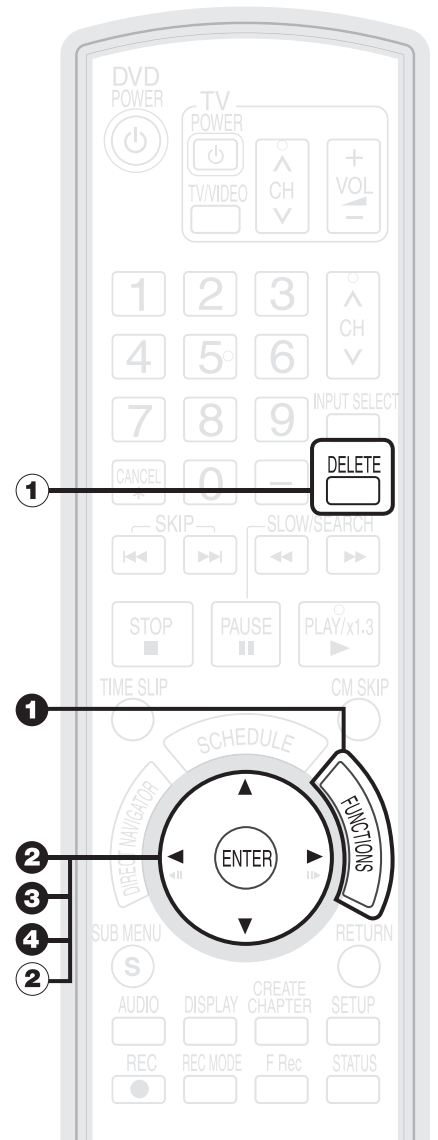

## Notes

- You cannot delete while recording.
- **+R +R DL +RW** Even if you have set protection on other equipment, such recordings are deleted.

## Tips

- Icons such as "**RAM**" indicate usable discs. Refer to pages 52 and 53.
- **RAM** Deleting an item increases the available disc space by the amount of space taken by the item deleted.
- **-R -R DL +R +R DL** Available disc space does not increase after deletion.
- **-RW(V) +RW** Available disc space increases when you delete the last recording (the recording space may increase slightly when other recordings are deleted).

# Important Notes for Recording

## Recording of multi lingual broadcasts

### Analog broadcasts:

#### RAM

Both Main and SAP audio can be recorded.

You can change the audio during playback. (→ 17, Changing Audio during Playback)

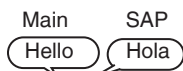

- If you record from external equipment Select both "Main" and "SAP" on the external equipment.

#### -R -R DL -RW(V) +R +R DL +RW

Select the Main or SAP audio before recording.

[→ 34, Multi-channel TV Sound (Analog)]

The selected audio only is recorded.

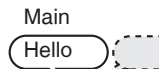

- If you record from external equipment Select "Main" or "SAP" on the external equipment.

### Digital broadcasts:

Press [AUDIO] to switch audio.

The selected audio only is recorded.

## Recording of Widescreen broadcasts

#### RAM

Recorded in 16:9 aspect (Widescreen)



- If you have a regular 4:3 aspect TV and you receive 16:9 aspect images from a digital broadcast, they will appear in the letterbox format (→ 66).

#### -R -R DL -RW(V) +R +R DL +RW

Recorded in 4:3 aspect



## Copy-once Recording

- It is not possible to record digital broadcasts that allow "One time only recording" onto DVD-R, DVD-R DL, DVD-RW, +R, +R DL, +RW or 8 cm (3") DVD-RAM discs. Use the CPRM (→ 66) compatible DVD-RAM.

RAM CPRM compatible discs only

#### -R -R DL -RW(V) +R +R DL +RW

12 cm (5")  **Yes**

 **No**

## Playing the disc on other DVD players

#### -R -R DL -RW(V) +R +R DL

The disc must be finalized after recording (→ 29).

It is necessary to finalize DVD-R, etc. on this unit after recording. You can then play them in the same manner as a commercially sold DVD-Video. However, the discs become play-only and you can no longer record.\*

\* You can record again if you format DVD-RW.



Record to DVD-R, etc.



Finalize

Play on other DVD equipment

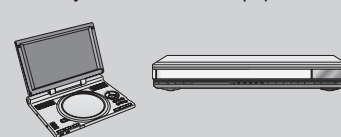

#### +RW

We recommend you create the menu before playing a +RW disc on other equipment (→ 29).

## Recording to DVD-R DL and +R DL

DVD-R DL and +R DL discs have two layers of recording surface on one side.

- **-R DL** Recordings are divided when recording changes from the first layer to the second. Some images and audio may be lost at this point.
- **+R DL** Recordings are not divided in this way when recording changes from the first layer to the second, but play may stop momentarily at the point where the layers change. Recordings are divided when they exceed 8 hours in length.

#### DVD-R DL

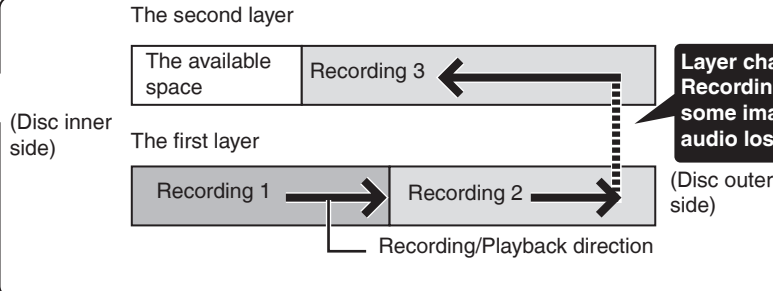
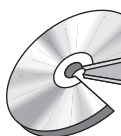

## Recording Modes and Durations

Recording Mode	DVD-RAM		DVD-R, DVD-RW, +R, +RW (4.7 GB)	DVD-R DL* <sup>3</sup> , +R DL* <sup>3</sup> (8.5 GB)
	Single-sided (4.7 GB)	Double-sided* <sup>1</sup> (9.4 GB)		
XP (High quality)	1 hour	2 hours	1 hour	1 hour 45 minutes
SP (Standard play)	2 hours	4 hours	2 hours	3 hours 35 minutes
LP (Long play)	4 hours	8 hours	4 hours	7 hours 10 minutes
EP (Extra long play)	8 (6* <sup>2</sup> ) hours	16 (12* <sup>2</sup> ) hours	8 (6* <sup>2</sup> ) hours	14 hours 20 minutes (10 hours 45 minutes* <sup>2</sup> )
FR (Flexible Recording)	8 hours maximum	8 hours maximum for one side	8 hours maximum	14 hours 20 minutes maximum

\*1 It is not possible to record or play continuously from one side of a double sided disc to the other.

\*2 When "Recording Time in EP Mode" has been set to "EP-Extended Play (6H)" in the Setup menu (→ 33).  
The sound quality is better when using "EP-Extended Play (6H)" than when using "EP-Extended Play (8H)".

\*3 Refer to "Recording to DVD-R DL and +R DL" (→ 10).

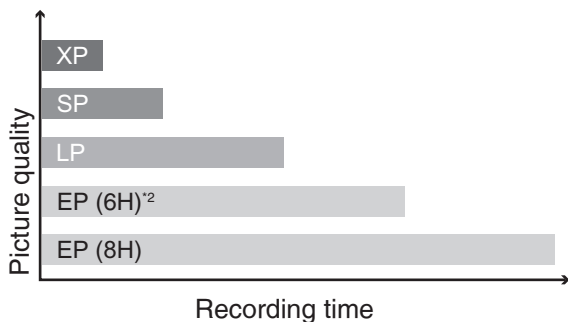

### Notes

- This unit uses variable bit rate (VBR) recording which varies the amount of data recorded to suit the images, so actual recording times and remaining recording times shown by the unit will be different. (-R DL +R DL) The difference will be especially noticeable.) Use a disc with plenty of remaining time to be sure.
- When recording to DVD-RAM using EP (8H) mode, play may not be possible on DVD players, even if they are compatible with DVD-RAM. In this case use EP (6H) mode.



### Tips

- **FR (Flexible recording mode)**  
You can set FR mode when programming scheduled recordings (→ 8) and flexible recording (→ 13).
- Maximum number of recordings to a disc  
**RAM -R -R DL -RW(V)** 99 recordings on a disc  
**+R +R DL +RW** 49 recordings on a disc
- **To prevent recording errors:**  
Set a scheduled recording period slightly longer than the actual program (to make sure the program is recorded in full).

# Advanced Recording

## When the format confirmation screen is displayed

Important:

Formatting permanently deletes all disc contents (including computer data), regardless of protection status of disc.

**RAM -RW(V) +RW**

The following screen may appear when inserting a new disc, etc.

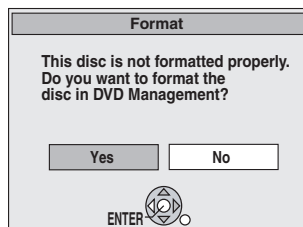

Only format the disc if you intend to use it for recording.

Do not format if you intend to view pre-recorded material from the disc.

◀ to select "Yes", then 

### Tips

- Refer to "Formatting Discs" (→ 28) for more detail of formatting.

## When removing a Recorded Disc

**-R -R DL -RW(V) +R +R DL**

After recording, if you press  [▲ OPEN/CLOSE] to eject the disc, the following screen may appear.

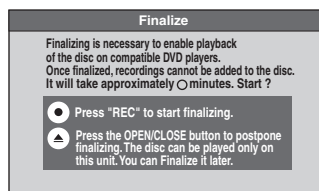

 to start finalizing.

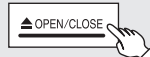
or  to eject the disc without finalizing.

### Notes

- You cannot stop finalizing once you have started it.

### Tips

- If you want to provide the disc with a name or set play menu select, select "Disc Name" (→ 27) or "Playback will start with:" (→ 28) in "DVD Management" before finalizing.

Refer to "Finalizing" (→ 29) for more detail of finalizing.

## Selecting Audio Channels to record

### When receiving an analog broadcast

**-R -R DL -RW(V) +R +R DL +RW**

Select the audio (Main or SAP) in "Multi-channel TV Sound (Analog)" in the Setup menu (→ 34).

**RAM**

AUDIO  to select the audio.

Stereo → SAP → Mono

Changing during recording changes the recorded sound.

<b>Stereo:</b>	<b>Main audio (stereo)</b> If the broadcast is "Mono+SAP", audio will be monaural even if you select Stereo mode.
<b>SAP:</b>	<b>Secondary audio program (SAP).</b> When you record SAP, main audio is also recorded. In such cases, recorded SAP and main audio become monaural.
<b>Mono:</b>	<b>Main audio (monaural).</b> Select "Mono" if reception is poor during a stereo broadcast.

e.g., "Stereo" is selected  
"(" appears when the unit is receiving the audio type you selected.

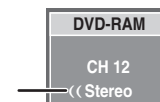

### Notes

- You cannot change the audio type in the following cases.  
– While a disc other than DVD-RAM is inserted when selecting an analog broadcast

### When receiving a digital broadcast

AUDIO  to select the audio.

e.g., "English" is selected

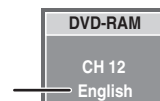

### Notes

- You cannot change the audio type in the following cases.  
– When there is no choice of languages in a digital broadcast
- Before scheduled recording a digital broadcast with more than one language channel, set the language in "Audio Language Setting" in the Setup menus (→ 32).
- When broadcast offers no language data, such displays as "Audio 1 of 3" may appear. In such cases, recording may not be possible in the language selected through the "Audio Language Setting" in the Setup menu.



# Advanced Recording

## Playing while you are recording

### Chasing Playback

#### RAM

Allows playback from the beginning of the recording you are recording.

During recording



(at least 20 seconds after recording starts).



#### Tips

##### To stop play

Press [■ STOP] once.

##### To stop recording

Press [■ STOP] at least 2 seconds after chasing playback stops.

### Simultaneous Record and Playback

#### RAM

Allows playback of a previous recording, while recording something else.

During recording



2

◀, ▶, ▲, ▼ to select the recording to play, then



#### Tips

##### To stop play

Press [■ STOP].

##### To exit the DIRECT NAVIGATOR screen

Press [DIRECT NAVIGATOR].

##### To stop recording

After play stops

1. Press [DIRECT NAVIGATOR] to exit screen.
2. Press [■ STOP].







#### Notes

- During playing while you are recording, you cannot edit or delete recordings.
- Closed captions will not appear during simultaneous record and playback.

# Advanced Scheduled Recording

## To cancel a scheduled recording in progress



**1**    
– Confirmation screen appears.



**2**  to select “Stop recording”, then  

### Notes

- Recording stops and the scheduled recording is deleted. (Daily and weekly schedules remain and scheduled recording will start as programmed.)

## To release the unit from recording standby (Before recording starts)

   
– The unit turns on and “” on the unit’s display goes out.

- Be sure to press [ DVD POWER] to return the unit to standby mode before the scheduled recording time. Scheduled recording will work only if “” is displayed.









## Check, Change, or Delete Programs



The scheduled recording list can be viewed even when the unit is off.

**1**    
– See “Tips” for explanation of icons displayed.

**2** ,  to select the program.

**3a**   or   to delete.  
– You cannot delete programs that are currently recording.

**3b**   to modify the program.  
, , ,  to make changes, then  

**4**    
– “” lights on the unit’s display.

### Notes





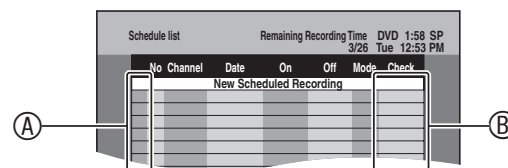

- Recording may fail if there are changes to the station’s programming.
- The password screen appears when setting parental ratings (→36). Unless you enter the correct password, recording the program with parental ratings may fail.

### Tips

- You can enter up to 16 programs a month in advance.



#### **A** Schedule list screen icons

- : Currently recording
- : Programs are overlapped. Recording of the program with the later start time starts when the earlier program finishes recording.
- : You stopped a weekly or daily scheduled recording. The icon disappears when the next scheduled recording starts.
- : The disc was full. (not enough space)
- : The TV program may not be recorded due to copy-protect or ratings.
- : Recording stopped (Dirty disc, etc.)
- PG!**: Recording may become impossible when a wrong password is entered through the unit’s parental rating setting procedure.

#### **B** Check

OK: Recordable

→ (Date): The last day of daily or weekly recording.

!: It may not be possible to record because:  
– the disc is write-protected.  
– there is no more space left.  
– the number of possible recordings has reached its maximum.

Overlap: When the date and time overlap with another scheduled recording, only a part of the program can be recorded.

# Advanced Playback

## Menu Screens on the TV

### DVD-V

Generally, menu screens that appear on the TV may be navigated as follows:

▲, ▼, ◀, ▶ to select an item, then



You can sometimes use the numbered buttons to select an item.



### Tips

#### To return to the menu screen

Press [DIRECT NAVIGATOR] or [SUB MENU].



### Notes

- If “⊘” appears on the TV, the operation is prohibited by the unit or disc.

## Selecting Recordings to Play

RAM -R -R DL -RW(V) +R +R DL +RW -RW(VR)

1

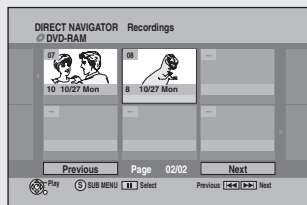

2

▲, ▼, ◀, ▶ to select the recording you want to watch, then



### Tips

#### To select the recording with the numbered buttons

e.g., “5”: [0] → [5]  
“15”: [1] → [5]

#### To view other pages

Press [▲, ▼, ◀, ▶] to select “Previous” or “Next” and press [ENTER].  
– You can also press [◀◀, ▶▶] to view other pages.

#### To exit the DIRECT NAVIGATOR screen

Press [DIRECT NAVIGATOR].

#### DIRECT NAVIGATOR screen icons

- 🔒 Protected.
- 🚫 Not recorded due to recording protection (Digital broadcasts, etc.)
- ✗ It cannot be played because data is damaged.
- Currently recording.
- 📄 “One time only recording” restriction (→ 66, CPRM)

## Search

During playback

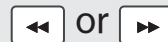

- There are 5 search speeds. Each press increases the search speed.
- Press [▶ PLAY] to restart normal playback.



### Tips

- Depending on the disc, search may not be possible.

## Skip

During playback or while paused

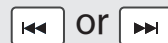

- Each press increases the number of skips.

## Direct Play

During playback, you can access specific recordings or scenes through direct entry of the numbered buttons.



e.g., “5”: [0] → [5]  
“15”: [1] → [5]



CD (MP3 and JPEG discs only)

e.g., “5”: [0] → [0] → [5]  
“15”: [0] → [1] → [5]



## Quick View (Play x1.3)

### RAM

Allows you to increase the play speed slightly without distorting the audio.

During playback



(Press and hold.)



- Press again to return to normal speed.



## Slow-motion Play

**RAM** **-R** **-R DL** **-RW(V)** **+R** **+R DL** **+RW**  
**DVD-V** **-RW(VR)**

While paused

 OR 

- There are 5 slow-motion speeds. Each press increases the speed.
- Press **[▶ PLAY]** to restart normal playback.





### Notes

- If continued for approx. 5 minutes, slow-motion play pauses automatically (except **DVD-V**).

## Frame-by-Frame Viewing

**RAM** **-R** **-R DL** **-RW(V)** **+R** **+R DL** **+RW**  
**DVD-V** **-RW(VR)**

While paused

 **ENTER** 

- Each press shows the next or previous frame.
- Press and hold to advance or reverse frame-by-frame in succession.
- Press **[▶ PLAY]** to restart normal playback.



## Time Slip

**RAM** **-R** **-R DL** **-RW(V)** **+R** **+R DL** **+RW** **-RW(VR)**

Use to skip in 1-minute or 10-minute increments.

During playback

**1** 

**2**  **▲**, **▼** to select the time, then 

- Each press of **▲** or **▼** advances the interval by 1 minute (press and hold for 10-minute intervals).

## CM Skip

**RAM** **-R** **-R DL** **-RW(V)** **+R** **+R DL** **+RW** **-RW(VR)**

Skips 1-minute forward with each press.

During playback

**CM SKIP** 

## Create Chapters

**RAM**

During playback

**CREATE CHAPTER** 



### Tips

- You can skip to the start of a chapter by pressing **[◀◀, ▶▶]**.

## Changing Audio during Playback

**AUDIO**  to select the audio.

Available audio will differ based on disc type. See below.

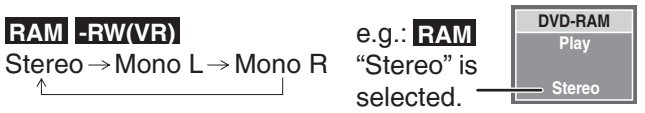

**RAM** **-RW(VR)** When playing an analog MTS broadcast, you can choose between Main Audio and SAP Audio.  
 Main Audio ↔ SAP Audio

### DVD-V

This allows you to change items like the audio channel number and the sound track language (→ 30).



e.g., English is the selected language.



### Notes

- If you cannot change the audio type when you have used only an optical digital audio cable for connection, set “Dolby Digital” to “PCM” (→ 34). Alternatively, you may connect to an amplifier or system component with an audio cable and change the input on the amplifier or system component to suit the connection (→ 43).

# Playing Still Pictures (JPEG), MP3

## Playing Still Pictures (JPEG)

CD

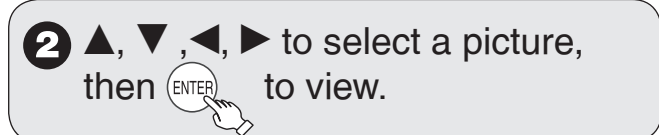
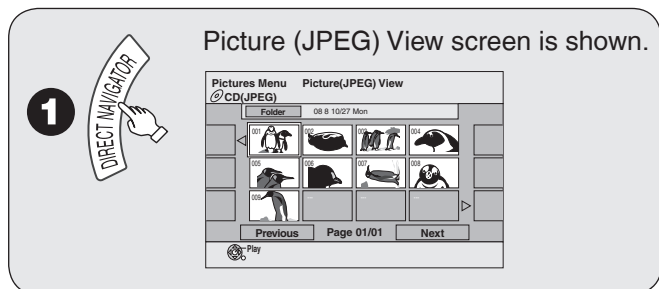

### Notes

- Still pictures (JPEG) recorded on CD-R/RW can be played on this unit.
- Thumbnails for large JPEG files and images with aspect ratios other than 4:3 may not display.

### Tips

**To stop viewing a picture**  
Press [■ STOP].

**To exit the menu screens**  
Press [DIRECT NAVIGATOR].

**To view other pages**  
Press [▲, ▼, ◀, ▶] to select "Previous" or "Next", then press [ENTER].  
You can also press [◀◀, ▶▶] to view other pages.

**To select the still picture with the numbered buttons**  
e.g., "5": [0] → [0] → [5]  
"15": [0] → [1] → [5]

### When you insert discs which contain both MP3 and still pictures (JPEG)

The screen shown below is displayed.

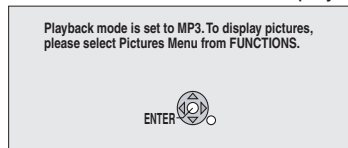

1. Press [ENTER] to exit the screen.
2. Press [FUNCTIONS].
3. Press [▲, ▼] to select "Menu", then press [ENTER].
4. Press [▲, ▼] to select "Pictures", then press [ENTER].

## Selecting Still Pictures in Another Folder

From the Picture (JPEG) View screen

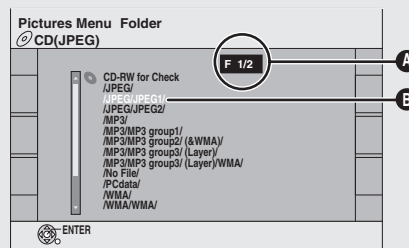
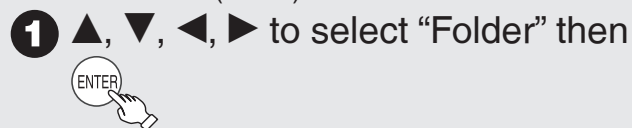

- A:** Selected Folder No./Total Folder No.  
If the folder has no compatible JPEG file "--" is displayed as the folder no.
- B:** Selected Folder

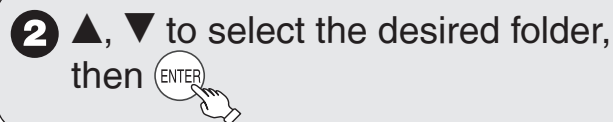

### Notes

- You cannot operate the scroll bar that appears in the Folder screen.

### Tips

**To return to the previous screen**  
Press [RETURN].

## Slideshow

From the Picture (JPEG) View screen

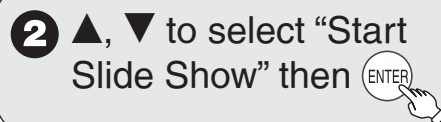

### Tips

**To stop the Slideshow**  
Press [■ STOP].

### To change the rate at which pictures are displayed

1. In step 2 above, press [▲, ▼] to select "Slide Interval", then press [ENTER].
2. Press [◀, ▶] to select desired interval (0 to 30 seconds), then press [ENTER].

## Rotate Pictures

While playing a picture

**1** SUB MENU

**2** ▲, ▼ to select “Rotate Right” or “Rotate Left”, then

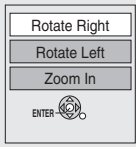

### Notes

**To return to the picture to its original position**  
 Press [▲, ▼] to select the opposite rotation in step 2 and press [ENTER].

- Rotation information is not stored.

## Zoom

While playing a picture

**1** SUB MENU

To zoom in:

**2** ▲, ▼ to select “Zoom In”, then

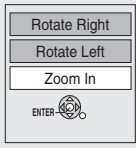

### Notes

**To return to the picture to its original size**  
 Press [▲, ▼] to select “Zoom out” in step 2 and press [ENTER].

- When zooming in, the still picture may be cut off.
- “Zoom In” information is not stored.
- “Zoom In” and “Zoom out” do not work with images that have a resolution larger than 640 x 480 pixels.

## Picture Properties

While playing a picture

twice to display picture properties.

Shooting Date

11/30 12:03 AM
Date 11/26/2004—No. 002/030

again to exit.

### Notes

- Depending on the camera or editing software, shooting dates may not be displayed correctly.

## Playing MP3s

### CD

**1**

Selected group

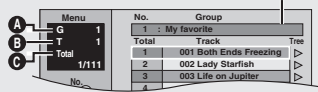

– Track list is shown.

**A**: Group No.  
**B**: Track No. in the group  
**C**: Track No./Total tracks in all groups

**2** ▲, ▼ to select a track, then

to play.

### Tips

- “” indicates the track currently playing.

**To stop playing**  
 Press [STOP].

**To exit the menu screens**  
 Press [DIRECT NAVIGATOR].

**To view other pages**  
 Press [◀, ▶].

**To select the track with the numbered buttons**  
 e.g., “5”: [0] → [0] → [5]  
 “15”: [0] → [1] → [5]

## Using the Tree Screen to Find a Group

From the track list

**1** while a track is highlighted to display the tree screen.

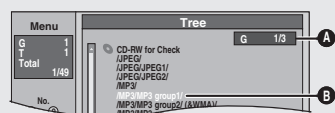

**A**: Selected Group No. /Total Group No.  
 If the group has no compatible track, “- -” is displayed as the group number.

**B**: Selected Group

**2** ▲, ▼ to select a group, then

– The track list for the selected group appears.

### Notes

- When there is a large amount of still picture data etc. within an MP3 file, play may not be possible.
- You cannot operate the scroll bar that appears in the tree screen.

### Tips

**To return to the track list**  
 Press [RETURN].

- When you insert discs which contain both MP3 and still pictures (JPEG), files selection screen appears. (→ 18, Tips)  
 Press [ENTER].

# Playing Playlists

## RAM -RW(VR)

You cannot create or edit playlists on this unit. However, you can play a playlist that has been created or edited on other equipment.

With the unit stopped

1



2 ▲, ▼ to select “Other Functions” then ENTER

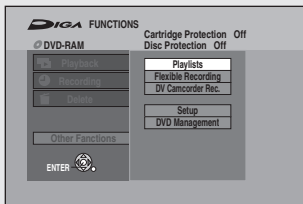

3 ▲, ▼ to select “Playlists”, then



4 ▲, ▼, ◀, ▶ to select the playlist to play, then



## Playlist Properties

After selecting a playlist (step 4)

5



6 ▲, ▼ to select “Properties”, then



– Playlist information (e.g., length and date) is shown.

## View Chapters

After selecting a playlist (step 4)

5



6 ▲, ▼ to select “View Chapters” then



7 ▲, ▼, ◀, ▶ to select the chapter, then



### Tips

#### To return to the playlist screen

Press [SUB MENU], then select “View Playlists” and press [ENTER].

#### To view other pages

Press [◀, ▶].

# Entering Text

**1** When viewing the Name screen.

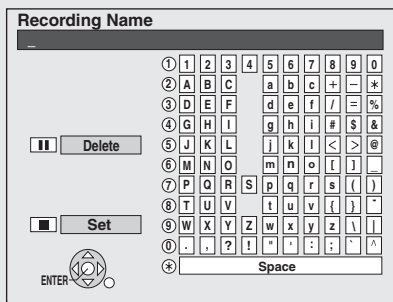

**2** ▲, ▼, ◀, ▶ to select characters then ENTER

– Repeat this step to enter other characters.

**3** STOP when you've finished entering text.

## Tips

### Using the numbered buttons to enter characters

- e.g.: entering the letter "R"
1. Press [7] to move to the 7th row.
  2. Press [7] twice to highlight "R".
  3. Press [ENTER].

### To enter a space

Press [\* CANCEL] then press [ENTER].

### To delete a character

Press [PAUSE] on a character in the name field.

### To cancel in the middle

Press [RETURN].  
Characters will not be saved.

## Notes

- Long recording names may not be displayed.

# Status Messages

The following messages and displays appear to let you know what operations are being performed and the status of the unit.

STATUS

– Press [STATUS] to cycle through available displays.

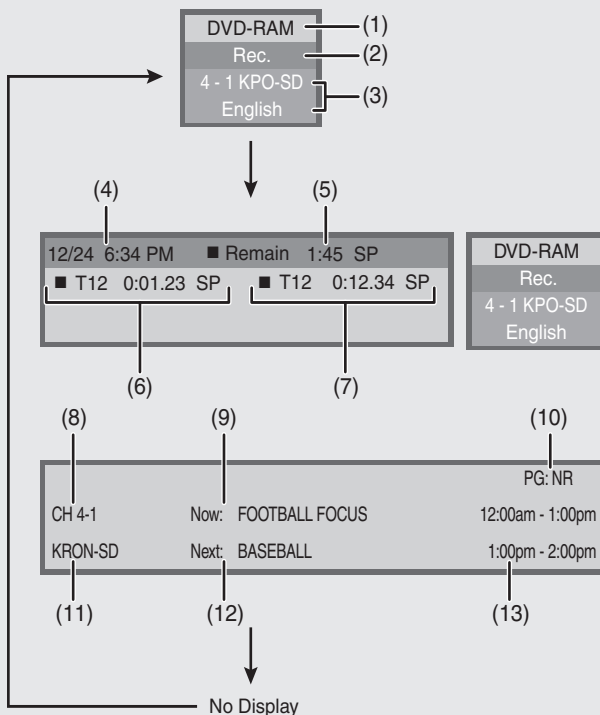

### ■ Display examples

- (1) Current media
- (2) Shows current recording or play status.
- (3) Channel information
- (4) The current date and time
- (5) Remaining recording time and recording mode (e.g.: "1:45 SP" indicates 1 hour and 45 minutes in SP mode)
  - Disc remaining time may slightly differ between different models.
- (6) Elapsed play time/Recording mode
- (7) Elapsed recording time and recording mode

### Only displayed when receiving a digital broadcast:

- (8) Channel
- (9) Current program
- (10) Parental Rating of the program (→ 37)
- (11) Channel caption
- (12) Next program
- (13) Start and finish times of the program

# Recording from an External Device

## Recording from a VCR, etc.

Connect cables while the power to both the unit and the external device is off.

Front of the unit

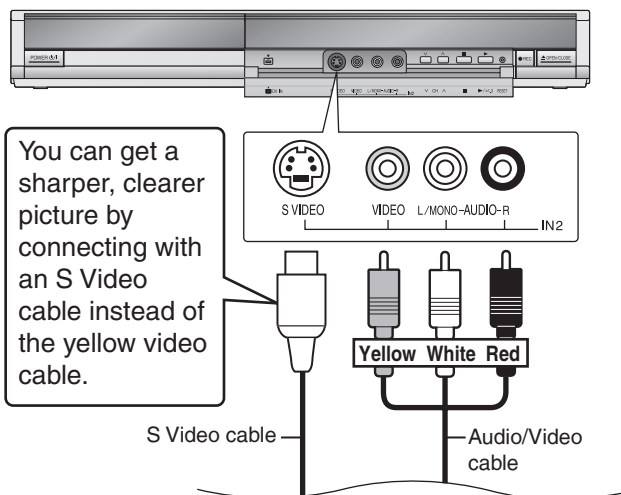

**6**  at the point you want to start recording to the disc.

### Tips

- You can also connect to the IN1 on the rear.
- If the audio output of the other equipment is monaural, connect to L/MONO on the IN2 input terminals at the front.

## RAM -R -R DL -RW(V) +R +R DL +RW

### Preparation:

- Turn on the unit and connected equipment.
- **RAM** If the disc is protected, release protection (→ 27).
- When recording MTS (Multi-channel TV Sound) broadcasts (→ 10)

**1** Insert a disc.

**2**  to select the recording mode (→ 11).

**3** 

**4** ▲, ▼ to select the input where your external device is connected, then 

– Front panel inputs are IN2.

Input Select	
1	TV
2	IN1
3	IN2
4	DV



**5** Start play on the external device.

## Recording from a DV Camcorder

Connect cables while the power to both the unit and the external device is off.

Front of the unit

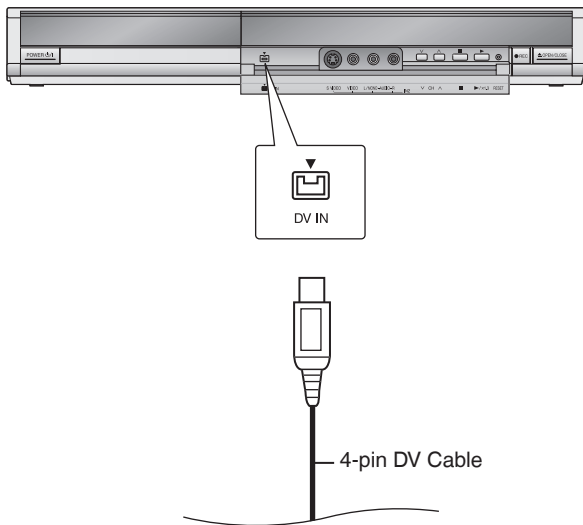

**RAM** **-R** **-R DL** **-RW(V)** **+R** **+R DL** **+RW**

### Preparation:

- Turn on the unit.
- **RAM** If the disc is protected, release protection (→ 27).

**1** Insert a disc.

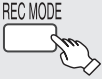
**2**  to select the recording mode (→ 11).

**3** Turn on the DV equipment and pause play on the DV equipment at the point you want recording to start.

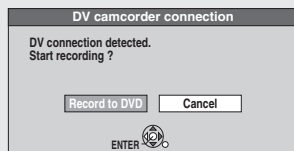

“DV camcorder connection” screen may appear.





### When “DV camcorder connection” screen does not appear

Perform steps 1–3 (→ above)

1. With the unit stopped  
Press [FUNCTIONS].
2. Press [**▲**, **▼**] to select “Other Functions” then press [ENTER].
3. Press [**▲**, **▼**] to select “DV Camcorder Rec.” then press [ENTER].  
You can proceed to step 5 (→ right).

**4**  to select “Record to DVD” and press .

**5**  to select “Rec.” then .



### Notes

- If the desired audio is not recorded, select the kind of audio for “Select Audio Channel For DV Input” in the Setup menu (→ 34).
- **RAM** Programs are recorded as a single item; breaks in the images create chapters.
- If you use video camcorders from other manufacturers, these are not guaranteed to work.
- It is not possible to operate the unit from the connected DV equipment.
- The DV equipment name may not be shown correctly.
- Date and time information is not recorded, even if displayed on the camcorder.
- The DV IN terminal is not meant to be connected to a computer.
- This unit uses a 4-pin “DV IN” connector;  
Your DV camcorder may use a 4-pin or 6-pin external connector. Please consult your DV camcorder’s manufacturer to confirm correct external connection.
- You cannot record and play simultaneously.



### Tips

#### When recording finishes

The confirmation screen appears.  
Press [ENTER] to finish DV camcorder recording.

#### To stop recording

Press [**■** STOP].  
The confirmation screen appears. Press [ENTER].

If the DV camcorder recording function does not work properly, check the connections and DV equipment settings, and turn the unit off and back on. If that does not work, follow the instructions on page 22.

# Recordings-Editing

## Tips

### Recording/Chapter

Normally, programs are recorded as a single item consisting of one chapter.

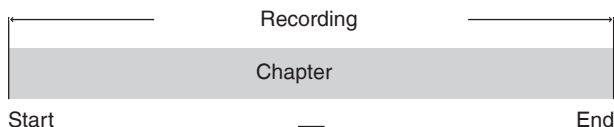

**RAM** You can divide a recording into multiple chapters.



After finalizing, recordings are divided into chapters of the following lengths.

**-R -R DL -RW(V)** : Chapters are approx. 5 minutes long

**+R +R DL** : Chapters are approx. 8 minutes long

### Maximum numbers of items on a disc

	<b>RAM -R -R DL -RW(V)</b>	<b>+R +R DL +RW</b>
Recordings	99	49
Chapters	Approx. 1000	Approx. 254

## Accessing the Recording View



**2** ▲, ▼, ◀, ▶ to select a recording.

– Multiple editing (→ right, Tips)

**3** **S** to display the menu list.

### To view more options

Press [▲, ▼] to select “Edit Recording”, then press [ENTER].

- Items that cannot be selected are grey.

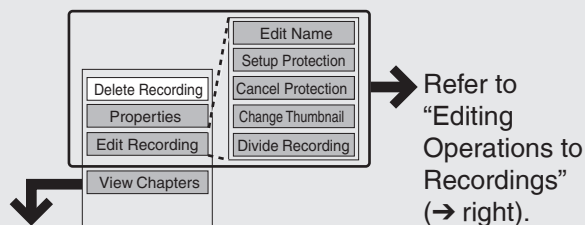

If you select “View Chapters” (→ 26)

## Notes

- You cannot edit during recording.
- **+R +R DL** Management information is recorded in unused sections when you edit discs. The available space on these discs decreases each time you edit their contents.

## Tips

### To exit the menu screens

Press [DIRECT NAVIGATOR].

### To view other pages

Press [▲, ▼, ◀, ▶] to select “Previous” or “Next” and press [ENTER].

– You can also press [◀◀, ▶▶] to view other pages.

### Multiple editing

Select with [▲, ▼, ◀, ▶] and press [|| PAUSE]. (Repeat.)

– A check mark appears. Press [|| PAUSE] again to cancel.

## Editing Operations to Recordings

### Delete Recording

Perform steps 1–3 of “Accessing the Recording View”.

**RAM -R -R DL -RW(V) +R +R DL +RW**

Important: Once deleted, contents cannot be recovered.

**4** ▲, ▼ to select “Delete Recording”, then to confirm.

**5** ◀ to select “Delete” then to confirm.

### Recording Properties

Perform steps 1–3 of “Accessing the Recording View”.

**RAM -R -R DL -RW(V) +R +R DL +RW -RW(VR)**

**4** ▲, ▼ to select “Properties”, then .

– Recording information is shown (e.g., date, time).



### Recording Name

Perform steps 1–3 of “Accessing the Recording View”.

**RAM -R -R DL -RW(V) +R +R DL +RW**

**4** ▲, ▼ to select “Edit Name” then .

– You can give a name for the recording (→ 21).





## Setup Protection / Cancel Protection

Perform steps 1–3 of “Accessing the Recording View” (→ 24).

### RAM

Use to prevent accidental erasure of recordings.

**4** ▲, ▼ to select “Setup Protection” or “Cancel Protection”, then 

**5** ◀ to select “Yes”, then 

The lock symbol appears when the recording is protected.

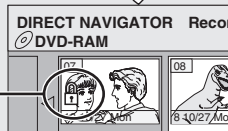

## Change Thumbnail

Perform steps 1–3 of “Accessing the Recording View” (→ 24).

### RAM -R -R DL -RW(V) +R +R DL +RW

Changes the thumbnail picture shown in the Recording View screen.

**4** ▲, ▼ to select “Change Thumbnail”, then 

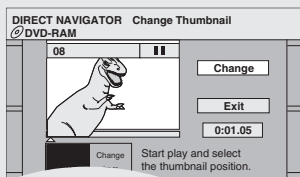

**5**  to start play.

**6**  at the point you want to use as the thumbnail.

– To change the thumbnail:  
Restart play and press [▲, ▼] to select “Change” then press [ENTER] at the point you want to use as the thumbnail.

**7** ▲, ▼ to select “Exit”, then 

## Tips

### For quicker editing

- Use search (→ 16), Slow-motion (→ 17) or Time Slip (→ 17) to find the desired point.
- To skip to the start or end of a recording, press [◀◀] (start) or [▶▶] (end).
- For better precision, use Slow-motion (→ 17) and Frame-by-Frame (→ 17).

## Divide Recording

Perform steps 1–3 of “Accessing the Recording View” (→ 24).

### RAM

Once divided, recordings cannot be recombined.

**4** ▲, ▼ to select “Divide Recording” then 

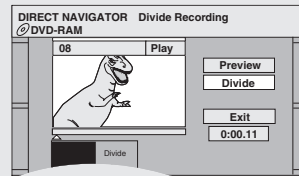

**5**  at the point you want to divide.

- For quicker editing (→ Left, Tips)
- Selecting “Preview” then pressing [ENTER] plays the recording from 10 seconds prior, to 10 seconds after the division point.
- To change the point to divide at:  
Restart play and press [▲, ▼] to select “Divide” then press [ENTER] to bring to the point where you want to divide.

**6** ▲, ▼ to select “Exit” then 

**7** ◀ to select “Divide” then   
– The recording is divided at that point.

## Notes

- Divided recordings retain the name of the original.
- A short amount of video and audio just before and after the division point gets cut out.
- You cannot divide a recording when the resulting parts are too short or when the total number of recordings exceeds 99.

# Chapters-Creating, Editing

## Accessing the Chapter View

### RAM

Allows viewing and editing chapters individually.

1



2

▲, ▼, ◀, ▶ to select a recording.

3

SUB MENU



to display the menu list.

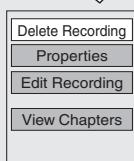

4

▲, ▼ to select “View Chapters”,  
then 

5

▲, ▼, ◀, ▶ to select a chapter.  
– Multiple editing (→ Tips)

6a

To play, 

6b

To edit,  to display the  
menu list.

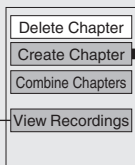

→ Refer to “Chapter Operations”  
(→ right).

You can go back to the Recording View.



### Tips

#### To exit the menu screens

Press [DIRECT NAVIGATOR].

#### To view other pages

Press [▲, ▼, ◀, ▶] to select “Previous” or “Next” and press [ENTER].

– You can also press [◀◀, ▶▶] to view other pages.

#### Multiple editing

Select with [▲, ▼, ◀, ▶] and press [|| PAUSE]. (Repeat.)

– A check mark appears. Press [|| PAUSE] again to cancel.

## Chapter Operations

### Create Chapter

Perform steps 1–6b of “Accessing the Chapter View” (→ left).

7

▲, ▼ to select “Create Chapter”  
then 

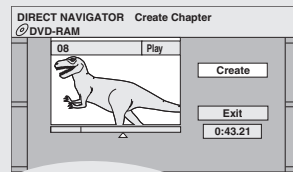

8

 at the point you want to  
divide.

9

▲, ▼ to select “Exit” then 



### Notes

- A short portion of the recording just after the creation point may be lost.



### Tips

For quicker editing (→ 25, Tips)

### Delete Chapter

Important: Once deleted, recorded contents cannot be recovered.

Perform steps 1–6b of “Accessing the Chapter View” (→ left).

7

▲, ▼ to select “Delete Chapter”,  
then 

8

◀ to select “Delete”, then 

### Combine Chapters

Perform steps 1–6b of “Accessing the Chapter View” (→ left).

7

▲, ▼ to select “Combine  
Chapters”, then 

8

◀ to select “Combine”  
then 

– The selected chapter gets combined with the  
next chapter.

# DVD Management

## Accessing the Management Menus

### Preparation:

- **RAM** Release protection (disc, cartridge → right).
- Insert a disc.

With the unit stopped

1



2 ▲, ▼ to select “Other Functions” then

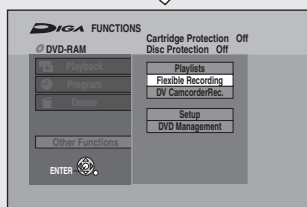

3 ▲, ▼ to select “DVD Management”, then



### Tips

**To return to the previous screen**

Press [RETURN].

**To exit the screen**

Press [RETURN] several times.

## Naming Discs

**RAM** -R -R DL -RW(V) +R +R DL +RW

Perform preparation steps 1–3 of “Accessing the Management Menus” (→ left).

4 ▲, ▼ select “Disc Name” then,



– You can give a name for the disc (→21).



### Tips

- The disc name is displayed in the DVD MANAGEMENT window.
- With a finalized discs and +RW, the name is displayed on the Top Menu.

## Setting Protection

**RAM**

Perform preparation steps 1–3 of “Accessing the Management Menus” (→ left).

4 ▲, ▼ select “Disc Protection” then



5 ◀ to select “Yes” then



– Some options require different operations; follow the on-screen prompts.

## Protection of cartridge disc

**RAM** (With a cartridge)

With the write-protect tab in the protect position, you cannot record to, edit, format, or delete from the disc.

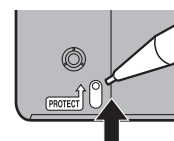

# DVD Management

## Deleting All Recordings

Important: Once deleted, contents cannot be recovered.

### RAM

Perform preparation steps 1–3 of “Accessing the Management Menu” (→ 27).

**4** ▲, ▼ select “Delete All Recordings” then 

**5** ◀ to select “Yes” then 

**6** ◀ to select “Start” then   
– A message appears when deleting is finished.

**7**  to complete.



### Notes

- Deleting does not work if one or more recordings are protected.

## Formatting Discs

Important: Once formatted, contents cannot be recovered.

### RAM -RW(V) +RW -RW(VR)

Perform preparation steps 1–3 of “Accessing the Management Menu” (→ 27).

**4** ▲, ▼ to select “Format Disc (DVD)” then 

**5** ◀ to select “Yes” then 

**6** ◀ to select “Start” then   
– Formatting starts (**RAM** may take up to a maximum of 70 minutes).  
– A message appears when formatting is finished.

**7**  to complete.



### Notes

- Do not disconnect the AC power supply cord while formatting. This can render the disc unusable.
- When a disc has been formatted using this unit, it may not be possible to use it on any other equipment.
- **-R -R DL +R +R DL CD** Formatting cannot be performed.
- **-RW(V) -RW(VR)** You can format only as DVD-Video format on this unit.
- **RAM** Pressing [RETURN] during format will cancel the process. The disc must be reformatted if you do this.
- **RAM** The disc cannot be formatted if the write protect tab (→ 27) is switched to “PROTECT”. Release the protection to continue.
- The message “Unable to format” appears when trying to format discs the unit cannot use.

## Selecting Whether to Show the Top Menu First

### -R -R DL -RW(V) +R +R DL +RW

Before finalizing a disc, select whether the top menu shows after finalizing.

Perform preparation steps 1–3 of “Accessing the Management Menu” (→ 27).

**4** ▲, ▼ to select “Playback will start with:”, then 

**5** ▲, ▼ to select desired item, then



- DVD's Top Menu:  
The Top Menu appears first.
- First Recording:  
The disc content is played without displaying the Top Menu.

## Finalizing

### **-R -R DL -RW(V) +R +R DL**

You can play these discs on compatible DVD players by finalizing it on the unit.

The menu you create with the unit can also be used on most DVD players.

Perform preparation steps 1–3 of “Accessing the Management Menus” (→ 27).

**4** ▲, ▼ to select “Finalize”, then



**5** ◀ to select “Yes”, then



**6** ◀ to select “Start”, then



- Finalizing starts and cannot be canceled. (may take up to 15 minutes)  
( **-R DL +R DL** up to 60 minutes)
- A message appears when finalizing is finished.

**7** ENTER to complete.



### Notes

- Do not disconnect the AC power supply cord while finalizing. This can render the disc unusable.
- When finalizing a high-speed recording compatible disc, it may take longer than displayed on the confirmation screen (approximately 4 times longer).
- After finalizing
  - **-R -R DL +R +R DL** The disc becomes play-only and you can no longer record or edit it.
  - **-RW(V)** You can record and edit the disc after formatting although it becomes play-only after finalizing.
  - The disc finalized on the unit may not be playable on other players depending on the condition of the recording.
  - There is a pause of several seconds between recordings and chapters during playback.
  - Recordings are divided into about 5-minute chapters\* (**+R +R DL** 8 minutes).

\* This time varies greatly depending on the condition and mode of recording.

### Tips

- After you have finished recording and try to eject the disc, a screen asking if you want to finalize the disc appears (→12).

## Create Top Menu

### **+RW**

+RW discs contain no Top Menu Data. Top Menu is a convenient function. We recommend you create the menu before playing a +RW disc on other equipment.

Perform preparation steps 1–3 of “Accessing the Management Menus” (→ 27).

**4** ▲, ▼ to select “Create DVD Top Menu”, then



**5** ◀ to select “Start”, then



**6** ◀ to select “Start”, then



- “Create DVD Top Menu” cannot be canceled once started.
- “Create DVD Top Menu” takes a few minutes.

**7** ENTER to complete.



### Notes

- Recording or editing on the disc may delete the top menu. In that case, create the top menu again.
- You cannot use the top menu for playing on this unit.

# Setting On-Screen Menus

## Accessing the On-Screen Menus

When playing discs, disc settings can be displayed and changed.

Menu options will differ based on disc type and contents.

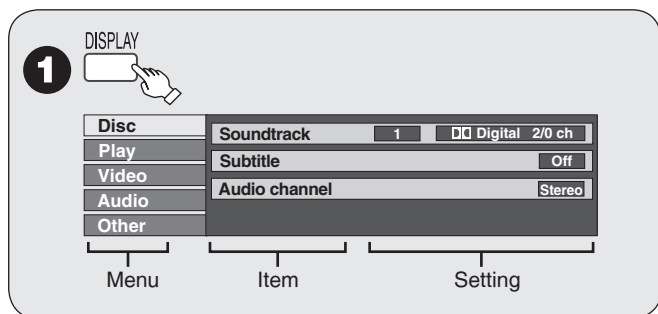

2 ▲, ▼ to select a menu then ►.

3 ▲, ▼ to select an item then ►.

4 ▲, ▼ to select a setting.

Follow the on-screen prompts to change individual settings.



### Notes

- Some settings may not be changeable, based on the unit's current activity (playing, stopped, etc.) and disc contents.



### Tips

**To exit the on-screen menus**  
Press [DISPLAY].

## Disc Menu

RAM -R -R DL -RW(V) +R +R DL +RW DVD-V  
-RW(VR)

### Soundtrack

RAM -R -R DL -RW(V) +R +R DL +RW -RW(VR)

The disc's audio attributes appear. (→ below, Audio attributes)

DVD-V

Select the audio and language.

(→ below, Audio attributes, Sound track/Subtitle language)

### Subtitle

RAM -R -R DL -RW(V) +R +R DL +RW -RW(VR)

(Only discs that contain subtitle on/off information)

Turn the subtitle on/off.

- Subtitle on/off information cannot be recorded using this unit.
- If the subtitles overlap the closed captions recorded on discs, turn the subtitles off.

DVD-V

Turn the subtitle on/off and select the language. (→ below, Sound track/Subtitle language)

### Audio channel RAM -RW(VR)

"Changing Audio during Playback" (→ 17)

### Angle DVD-V

Change the number to select an angle.

### Sound track/Subtitle language

CES:	Czech	MAL:	Malay
CHI:	Chinese	NLD:	Dutch
DAN:	Danish	NOR:	Norwegian
DEU:	German	POL:	Polish
ENG:	English	POR:	Portuguese
ESP:	Spanish	RUS:	Russian
FIN:	Finnish	SLK:	Slovak
FRA:	French	SVE:	Swedish
HUN:	Hungarian	THA:	Thai
ITA:	Italian	VIE:	Vietnamese
JPN:	Japanese	*	Others
KOR:	Korean		

### Audio attributes

LPCM/Digital/DTS/MPEG: Signal type

k (kHz):	Sampling frequency
b (bit):	Number of bits
ch (channel):	Number of channels



### Notes

- You cannot make a change when there is no recording.
- Some discs allow changes to sound tracks, subtitles, and angles only by using the disc's menus (→ 16).

## Play Menu

RAM -R -R DL -RW(V) +R +R DL +RW DVD-V  
-RW(VR) CD

### Repeat play

This function works only when the elapsed play time is displayed.

Select the item for repeat play. Depending on the disc, the items that can be selected will differ.

Select "Off" to cancel.

## Video Menu

RAM -R -R DL -RW(V) +R +R DL +RW DVD-V  
-RW(VR)

### Picture

Set picture mode.

Normal: Default setting

Cinema: Mellows movies, enhances detail in dark scenes.

### DNR (Digital Noise Reduction)

“On” reduces noise and picture degradation.

### Progressive [Only when you have selected “480p” in “TV Type” (→ 46)]

Select “On” to enable progressive output.

- Select “Off” if the picture is stretched horizontally.
- When progressive output on, you cannot use the TV’s closed captions, but you can use this unit’s closed captions. Go to this unit’s Setup menu to turn on closed captions. (→ 35).

### Transfer [Only when you have selected “On” in “Progressive” (→ above)]

Select the method of conversion for progressive output to suit the type of material being played.

Auto1 (normal): Film and video contents are detected automatically and converted properly.

Auto2: When using “Auto1” and video content is distorted as shown below.



### Line-in NR (Only when IN1 or IN2 is selected)

Reduces video tape noise during recording. Depending on the video signal, jittering may occur.

On: Noise reduction works for any video input.

Off: Noise reduction is off. Select when you want to record input as is.

## Audio Menu

RAM -R -R DL -RW(V) +R +R DL +RW DVD-V  
-RW(VR)

### V. Surround Sound (Dolby Digital with 2.0 or over channels only)

This function does not work for SAP recordings.

- Enjoy a surround-sound effect if you are using 2 front speakers (L/R) only.
- Turn off if it causes distortion.

Natural / Emphasis / Off

### Dialog Enhancer (Dolby Digital, 3-channel or over only, including a center channel)

When “On”, the volume of the center channel is raised to make dialogue easier to hear.

## Other Menu

### Signal meter

Allows you to check the strength of the digital broadcast signal.

- Only the strength of the digital broadcast received through the antenna is displayed accurately.

### Position

Change where this menu screen appears on your TV.

# Changing the Unit's Settings

## Accessing the Setup menu

With the unit stopped



**2** ▲, ▼ to select a menu then ► to go to the item list.

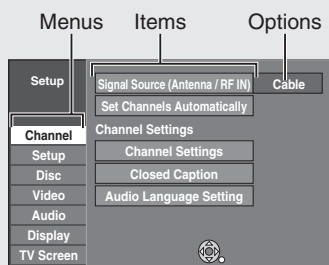

**3** ▲, ▼ to select an item to change then 

**4** ▲, ▼ to select an option then 

– Some options require different operations; follow the on-screen prompts.



### Notes

- Changed settings remain intact even when switching the unit to standby.



### Tips

#### To return to the previous screen

Press [RETURN]. Even if you have changed an option, the change is not activated until you press [ENTER].

#### To exit the screen

Press [SETUP].

## Summary of Settings

All factory default settings are indicated with “Underlined>

### Channel

#### Signal Source (Antenna / RF IN)

Select to suit the type of antenna you are using.

[Antenna] [Cable]

#### Set Channels Automatically

#### Channel Settings (→ 46)

#### Closed Caption (→ 35)

[Set]: Choose whether to show closed captions.

[Analog]: Settings for closed captions in analog broadcasts.

[Digital]: Settings for closed captions in digital broadcasts.

[Digital Setting]: Detailed settings for closed captions.

[CC reset]: Resets settings for closed captions.

• For details (→ 35, Setting the Closed Caption)

#### Audio Language Setting

Select the preferred digital broadcast language.

[English] [French] [Spanish]

### Setup

#### Off Timer

Select how long the unit remains on when it is not being used.

[2 Hours] [6 Hours] [Off]

#### Remote Control Code (→ 55)

[Set Code 1] [Set Code 2] [Set Code 3]

#### Clock Settings

Press [ENTER] to show the following settings.

#### Set Clock Automatically (→ 47)

#### Set Clock Manually (→ 45)

#### Set the time change dates for DST (→ 45)

Set the beginning and end dates for DST.

#### Adjust Time Zone (→ 47)

This corrects the time set in Auto Clock Setting.

The status is not displayed on the Setup menu when the Auto Clock Setting is not set.

[-1] [0] [1]

#### Quick Start

1 Sec. Quick Start for Recording on DVD-RAM.

From the power off state, recording on DVD-RAM starts about

1 second after first pressing [⏻ DVD POWER] and then

sequentially pressing [● REC] (Quick Start Mode).

Power consumption is also higher when the unit is turned off if this is set to “On”.

[On] [Off]

#### Restore Default Settings

This returns Setup menus to default settings, except for the clock, channel settings, ratings level, closed caption, and on-screen language.

[Yes] [No]



## Disc

### Settings for Playback

Press [ENTER] to show the following settings.

#### Ratings

Set a ratings level to limit DVD-Video play.

Follow the on-screen instructions. Enter a 4-digit password with the numbered buttons when the password screen is shown.

Do not forget your password.

- Setting ratings (When level 8 is selected)

[8 No Limit]: All DVD-Video can be played.

[1] to [7]: Prohibits play of DVD-Video with corresponding ratings recorded on them.

[0 Lock All]: Prohibits play of all DVD-Video.

- Changing ratings (When level 0 to 7 is selected)

[Unlock Recorder] [Change Password] [Change Level]

[Temporary Unlock]

#### Audio Language

[English] [French] [Spanish] [Original] [Other \*\*\*\*]

#### Subtitle Language

[Automatic] [English] [French] [Spanish] [Other \*\*\*\*]

#### Menu Language

[English] [French] [Spanish] [Other \*\*\*\*]



## Notes

**DVD-V** Choose the language for audio, subtitles and disc menus.

If a language which is not recorded is selected, or if languages are already fixed on the disc, the language set as the default on the disc will be played instead.

[Original] The original language of each disc will be selected.

[Other \*\*\*\*] This is the language code setting. Input a code number with the numbered buttons. (→ below "Language code list")

[Automatic] If the language selected for "Audio Language" is not available, subtitles of that language will automatically appear if available on the disc.

## Settings for Recording

Press [ENTER] to show the following setting.

### Recording Time in EP Mode

Select the maximum number of hours for recording in EP mode.

[EP-Extended Play (6H)]:

You can record for 6 hours on an unused 4.7 GB disc.

[EP-Extended Play (8H)]:

You can record for 8 hours on an unused 4.7 GB disc.

## Video

### Still Mode (paused video)

Select the type of picture shown when you pause play. (→ 66, "Frame and field")

[Automatic]

[Field] Select if jittering occurs when "Automatic" is selected.

[Frame] Select if you cannot see small text or fine patterns clearly when "Automatic" is selected.

### Black Level Control

Select "Normal", "Lighter" or "Darker" to adjust the black level control to the desired setting for picture enhancement.

Press [ENTER] to show the following settings.

#### Input Level

Adjusts the black level of the input signal.

[Lighter] [Darker]

#### Output Level (Composite/SVideo)

Adjusts the black level of the output signal from the VIDEO OUT and S VIDEO OUT terminal.

[Lighter] [Darker]

#### Output Level (Component)

Adjusts the black level of the output signal from the COMPONENT VIDEO OUT (Y/Pb/Pr) terminals.

[Lighter] [Normal] [Darker]

## Language code list

Enter the code with the numbered buttons.

Abkhazian: 6566	Chinese: 9072	Hausa: 7265	Lithuanian: 7684	Rhaeto-Romance: 8277	Tamil: 8465
Afar: 6565	Corsican: 6779	Hebrew: 7387	Macedonian: 7775	Macedonian: 8277	Tatar: 8484
Afrikaans: 6570	Croatian: 7282	Hindi: 7273	Malagasy: 7771	Romanian: 8279	Telugu: 8469
Albanian: 8381	Czech: 6783	Hungarian: 7285	Malay: 7783	Russian: 8285	Thai: 8472
Ameharic: 6577	Danish: 6865	Icelandic: 7383	Malayalam: 7776	Samoan: 8377	Tibetan: 6679
Arabic: 6582	Dutch: 7876	Indonesian: 7378	Maltese: 7784	Sanskrit: 8365	Tigrinya: 8473
Armenian: 7289	English: 6978	Interlingua: 7365	Maori: 7773	Scots Gaelic: 7168	Tonga: 8479
Assamese: 6583	Esperanto: 6979	Irish: 7165	Marathi: 7782	Serbian: 8382	Turkish: 8482
Aymara: 6589	Estonian: 6984	Italian: 7384	Moldavian: 7779	Serbo-Croatian: 8372	Turkmen: 8475
Azerbaijani: 6590	Faroese: 7079	Japanese: 7465	Mongolian: 7778	Shona: 8378	Twi: 8487
Bashkir: 6665	Fiji: 7074	Javanese: 7487	Nauru: 7865	Sindhi: 8368	Ukrainian: 8575
Basque: 6985	Finnish: 7073	Kannada: 7578	Nepali: 7869	Singhalese: 8373	Urdu: 8582
Bengali; Bangla: 6678	French: 7082	Kashmiri: 7583	Norwegian: 7879	Slovak: 8375	Uzbek: 8590
Bhutani: 6890	Frisian: 7089	Kazakh: 7575	Oriya: 7982	Slovenian: 8376	Vietnamese: 8673
Bihari: 6672	Galician: 7176	Kirghiz: 7589	Pashto,Pushto: 8083	Somali: 8379	Volapük: 8679
Breton: 6682	Georgian: 7565	Korean: 7579	Persian: 7065	Spanish: 6983	Welsh: 6789
Bulgarian: 6671	German: 6869	Kurdish: 7585	Polish: 8076	Sundanese: 8385	Wolof: 8779
Burmese: 7789	Greek: 6976	Laotian: 7679	Portuguese: 8084	Swahili: 8387	Xhosa: 8872
Byelorussian: 6669	Greenlandic: 7576	Latin: 7665	Punjabi: 8065	Swedish: 8386	Yiddish: 7473
Cambodian: 7577	Guarani: 7178	Latvian, Lettish: 7686	Quechua: 8185	Tagalog: 8476	Yoruba: 8979
Catalan: 6765	Gujarati: 7185	Lingala: 7678		Tajik: 8471	Zulu: 9085

# Changing the Unit's Settings

## Audio

### Dynamic Range Compression

**DVD-V** (Dolby Digital only)

Change the dynamic range (→ 66) for easier listening in low volume.

[On] [Off]

### Multi-channel TV Sound (Analog)

**-R -R DL -RW(V) +R +R DL +RW**

Select whether to record the main or secondary audio program (SAP) when recording to these discs. (You cannot select the audio type on the unit when recording from an external device. Select it on the external device.)

[Main] [Secondary Audio Program (SAP)]

### Digital Audio Output

Change the settings when you have connected equipment through the unit's DIGITAL AUDIO OUT terminal (→ 43).

Press [ENTER] to show the following settings.

#### PCM Down Conversion

Select how to output audio with a sampling frequency of 96 kHz or 88.2 kHz.

Signals are converted to 48 kHz or 44.1 kHz despite the settings if the signals have a sampling frequency of over 96 kHz or 88.2 kHz, or the disc has copy protection.

[On] Signals are converted to 48 kHz or 44.1 kHz. (Choose when the connected equipment cannot process signals with sampling frequency of 96 kHz or 88.2 kHz.)

[Off] Signals are output as 96 kHz or 88.2 kHz. (Choose when the connected equipment can process signals with sampling frequency of 96 kHz or 88.2 kHz.)

#### Dolby Digital \*

Choose whether to output by "Bitstream", which processes Dolby Digital signals on other connected equipment, or to convert the signals to "PCM (2ch)" on the unit before output.



[Bitstream] When you have connected the unit to equipment displaying the Dolby Digital logo.

[PCM] When you have connected the unit to equipment that doesn't have Dolby Digital logo.

#### DTS \*

Choose whether to output by "Bitstream", which processes DTS signals on other connected equipment, or to convert the signals to "PCM (2ch)" on the unit before output.



[Bitstream] When you have connected the unit to a piece of equipment displaying the DTS logo.

[PCM] When you have connected the unit to a piece of equipment that doesn't have DTS logo.

### Select Audio Channel For DV Input

You can select the kind of audio when recording from the unit's DV IN terminal (→ 23).

[Stereo 1] Records audio (L1, R1)

[Stereo 2] Records added audio such as narration (L2, R2) subsequent to original recording.

[Mix] Records both Stereo 1 and Stereo 2.

\* Incorrect settings can cause noise to be output which can be harmful to your ears and speakers, and audio will not be recorded properly on media such as mini discs.

## Display

### Status Messages

Choose whether to show status messages automatically or not.

[Automatic] [Off]

### On-screen Language

Choose the language for these menus and the on-screen messages.

[English] [Español] [Français]

### Black Background (Analog)

Select whether to show the black background, normally shown when TV reception is poor.

[On] [Off]

### Front Display

Changes the brightness of the unit's display.

[Bright]

[Dim]

[Automatic] The display turns dark during playback. When the unit is turned off, the unit's display disappears. While using this mode the standby power consumption can be reduced.

### Parental Rating (→ 36)

Enables you to limit viewing and recording of particular television programs.

[U.S. TV Rating]: U.S. TV program ratings

[MPAA Rating]: U.S. movie ratings

[CELR Rating]: Canadian English ratings

[CFLR Rating]: Canadian French ratings

[Change Password]

• For details (→ 37, Parental Rating List)

## TV Screen

### TV Type (→ 46)

Choose the setting to suit your TV and preference.

[Aspect 4:3 & 480i (interlace)] [Aspect 4:3 & 480p (progressive)]

[Aspect 16:9 & 480i (interlace)] [Aspect 16:9 & 480p (progressive)]

### 4:3 TV settings for DVD-Video

You can select how to display the image on the TV when you watch 16:9 images (DVD-Video) on a 4:3 standard aspect TV (→ 46).

[Pan and Scan (Stretch to fit)]:

Video recorded for a widescreen is played with the sides cut off if Pan & Scan was specified. If 16:9 software prohibits Pan & Scan, the image will appear in the letterbox style (with black bands above and below the picture) despite the setting here.

[Letterbox (Shrink to fit)]:

Video recorded for a widescreen is played in the letterbox style.

### 4:3 TV settings for DVD-RAM

You can select how to display the image on the TV when you watch 16:9 images (DVD-RAM) on a 4:3 standard aspect TV (→ 46).

[4:3]

Recordings are played as recorded.

[Pan and Scan (Stretch to fit)]

Video recorded for a widescreen is played with the sides cut off.

[Letterbox (Shrink to fit)]

Video recorded for a widescreen is played in the letterbox style.

## Setting the Closed Caption

Choose whether to show closed captions.

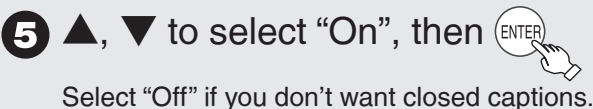

## Settings for closed captions in analog broadcasts

Perform steps 1-5 of “Setting the Closed Caption”.

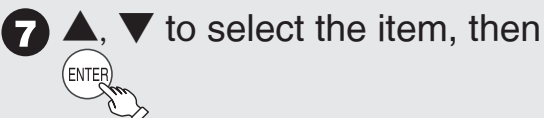
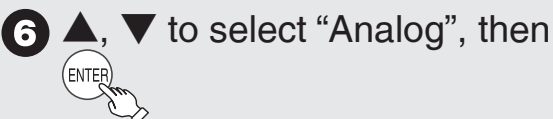

CC1-4: Information related to pictures (Appears at bottom of screen)

T1-4: Textual information (Appears over entire screen)

## Settings for closed captions in digital broadcasts

Perform steps 1-5 of “Setting the Closed Caption”.

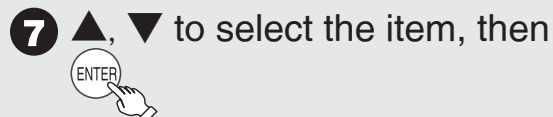
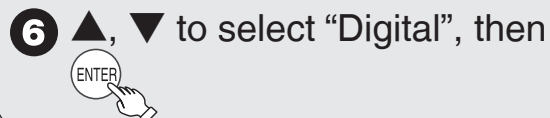

[Primary]: Primary Language  
[Secondary]: Secondary Language  
[Service 3]: Service 3 Language  
[Service 4]: Service 4 Language  
[Service 5]: Service 5 Language  
[Service 6]: Service 6 Language

## Detailed settings for closed captions in digital broadcasts

Perform steps 1-5 of “Setting the Closed Caption”.

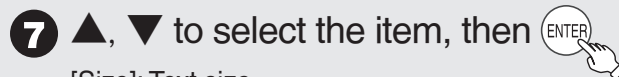
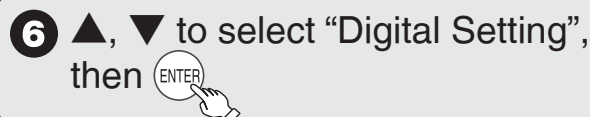

[Size]: Text size  
[Font]: Text font  
[Style]: Text style (Raised, Depressed, etc.)  
[Foreground]: Color of text  
[Fore Opacity]: Opacity of text  
[Background]: Color of text box  
[Back Opacity]: Opacity of text box  
[Outline]: Outline color of text (Identify the setting options on the screen.)

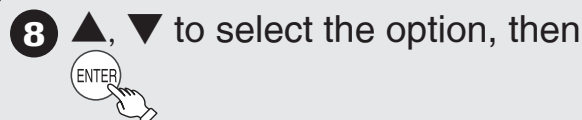

## Resets all settings for closed captions

Perform steps 1-5 of “Setting the Closed Caption”.

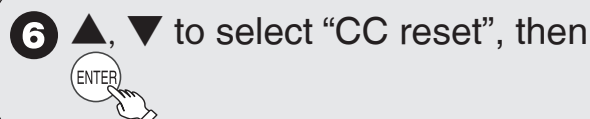

# Changing the Unit's Settings

## Setting the Parental Rating

The V-chip system (→ below, Notes) used in this unit allows you to limit viewing and recording of certain programs that may contain scenes unsuitable for children. If the unit starts receiving a broadcast with the set rating information, a password screen appears and you will be unable to view or record until you enter the password. You can view or record after entering your password.

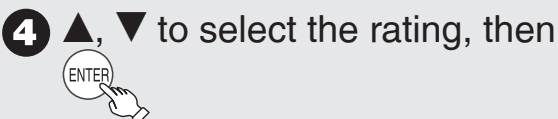
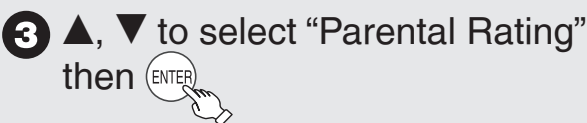

- U.S. TV Rating: U.S. TV program ratings
- MPAA Rating: U.S. movie ratings
- CELR Rating: Canadian English ratings
- CFLR Rating: Canadian French ratings

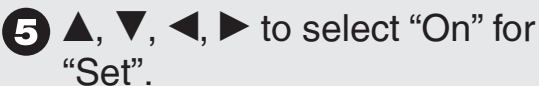

e.g., **U.S. TV Rating**

Setup	U.S. TV Rating	
	Set	On
Channel	TV-NR	Viewable
Setup	TV-Y	Viewable
Disc	TV-Y7	Viewable
Video	TV-G	Viewable
Audio	TV-PG	D -- L -- S -- V --
Display	TV-14	D -- L -- S -- V --
TV Screen	TV-MA	L -- S -- V --

- For details about other ratings (→ 37, Parental Rating List)

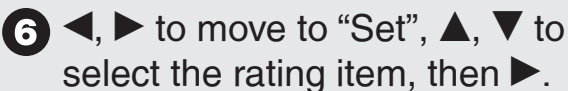

– The limitation options that appear depend on the rating you select in step 4. Select "Viewable", "--", or "Off" to cancel.

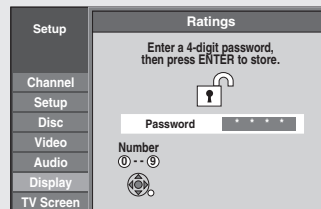
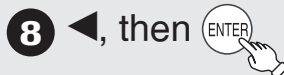

– A screen appears advising that you have set a password. Press [ENTER].

If you select "Off" for "Set":  
A screen appears advising that you haven't set a rating. Press [ENTER].

## To change the password

Perform steps 1-3 of "Setting the Parental Rating".

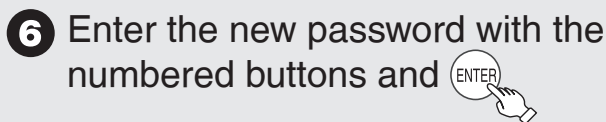
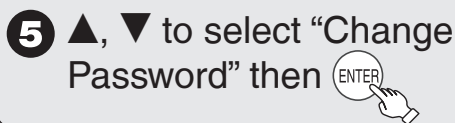
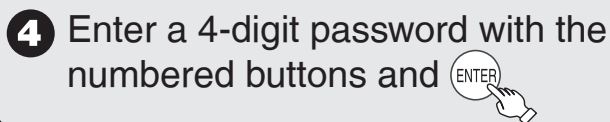

– A screen appears advising that you have set a password. Press [ENTER].



## Tips

### To clear the password

(→ 55, To reset the ratings level settings)



## Notes

- Recording may fail when a wrong password was entered for scheduled recording settings.
- "V-chip" technology enables restricted shows to be locked according to TV ratings.
- The V-chip system that is used in this set is capable of blocking "NR" programs (non rated, not applicable and none) as per FCC Rules Section 15.120(e)(2). If the option of blocking "NR" programs is chosen "unexpected and possibly confusing results may occur, and you may not receive emergency bulletins or any of the following types of programming:"
  - Emergency Bulletins (Such as EAS messages, weather warnings and others)
  - Locally originated programming • News • Political
  - Public Service Announcements • Religious • Sports • Weather

## Parental Rating List

### U.S. TV Rating (U.S. TV Program Ratings)

TV-NR	[Viewable] [Blocked]	Not Rated.
TV-Y	[Viewable] [Blocked]	All children. The themes and elements in this program are specifically designed for a very young audience, including children from ages 2-6.
TV-Y7	[FV Blocked] [Viewable] [Blocked]	Directed to older children. Themes and elements in this program may include mild physical or comedic violence, or may frighten children under the age of 7.
TV-G	[Viewable] [Blocked]	General audience. It contains little or no violence, no strong language, and little or no sexual dialogue or situations.
TV-PG	[--]:Viewable [X]:Blocked • D,L,S,V (all selected) • Any combination of D, L, S, V	Parental guidance suggested. The program may contain infrequent coarse language, limited violence, some suggestive sexual dialogue and situations.
TV-14	[--]:Viewable [X]:Blocked • D,L,S,V (all selected) • Any combination of D, L, S, V	Parents strongly cautioned. This program may contain sophisticated themes, sexual content, strong language and more intense violence.
TV-MA	[--]:Viewable [X]:Blocked • L,S,V (all selected) • Any combination of L, S, V	Mature audiences only. This program may contain mature themes, profane language, graphic violence, and explicit sexual content.

[FV]: Fantasy/Cartoon Violence [D]: Dialogue with sexual content [L]: Offensive Language [S]: Sex [V]: Violence

### MPAA Rating (U.S. Movie Ratings)

NR	[Viewable] [Blocked]	Not Rated.
MPAA	[Off]	MPAA Rating is set to "off".
	[G]	General audiences. All ages admitted.
	[PG]	Parental guidance suggested. Some material may not be suitable for pre-teenagers.
	[PG-13]	Parents strongly cautioned. Some material may be inappropriate for children under 13.
	[R]	Restricted. Under 17 requires accompanying parent or adult guardian.
	[NC-17]	No one 17 and under admitted.
	[X]	Adults only.

### CELR Rating (Canadian English Ratings)

E	[Viewable] [Blocked]	Exempt - Exempt programming includes: news, sports, documentaries and other information programming, talk shows, music videos, and variety programming.
CELR	[Off]	CELR Rating is set to "off".
	[C]	Programming intended for children under age 8. No offensive language, nudity or sexual content.
	[C8+]	Programming generally considered acceptable for children 8 years and over. No profanity, nudity or sexual content.
	[G]	General programming, suitable for all audiences.
	[PG]	Parental Guidance suggested. Some material may not be suitable for children.
	[14+]	Programming contains themes or content which may not be suitable for viewers under the age of 14. Parents are strongly cautioned to exercise discretion in permitting viewing by pre-teens and early teens.
	[18+]	18+ years old. Programming restricted to adults. Contains constant violence or scenes of extreme violence.

### CFLR Rating (Canadian French Ratings)

E	[Viewable] [Blocked]	Exempt - Exempt programming.
CFLR	[Off]	CFLR Rating is set to "off".
	[G]	General - Programming intended for audience of all ages. Contains no violence, or the violence content is minimal or is depicted appropriately.
	[8 ans+]	8+ General - Not recommended for young children. Programming intended for a broad audience but contains light or occasional violence. Adult supervision recommended.
	[13 ans+]	Programming may not be suitable for children under the age of 13 - Contains either a few violent scenes or one or more sufficiently violent scenes to affect them. Adult supervision strongly suggested.
	[16 ans+]	Programming may not be suitable for children under the age of 16 - Contains frequent scenes of violence or intense violence.
	[18 ans+]	Programming restricted to adults. Contains constant violence or scenes of extreme violence.

# Basic Connection

**Note:** The terminals on the rear of your TV may not appear as shown below.  
Please read terminal labels carefully to ensure correct connections.

- If your TV does not have AV IN terminals (→ 41).

## Connecting to a Television with Direct Cable or Antenna (No Cable Box or Satellite Receiver)

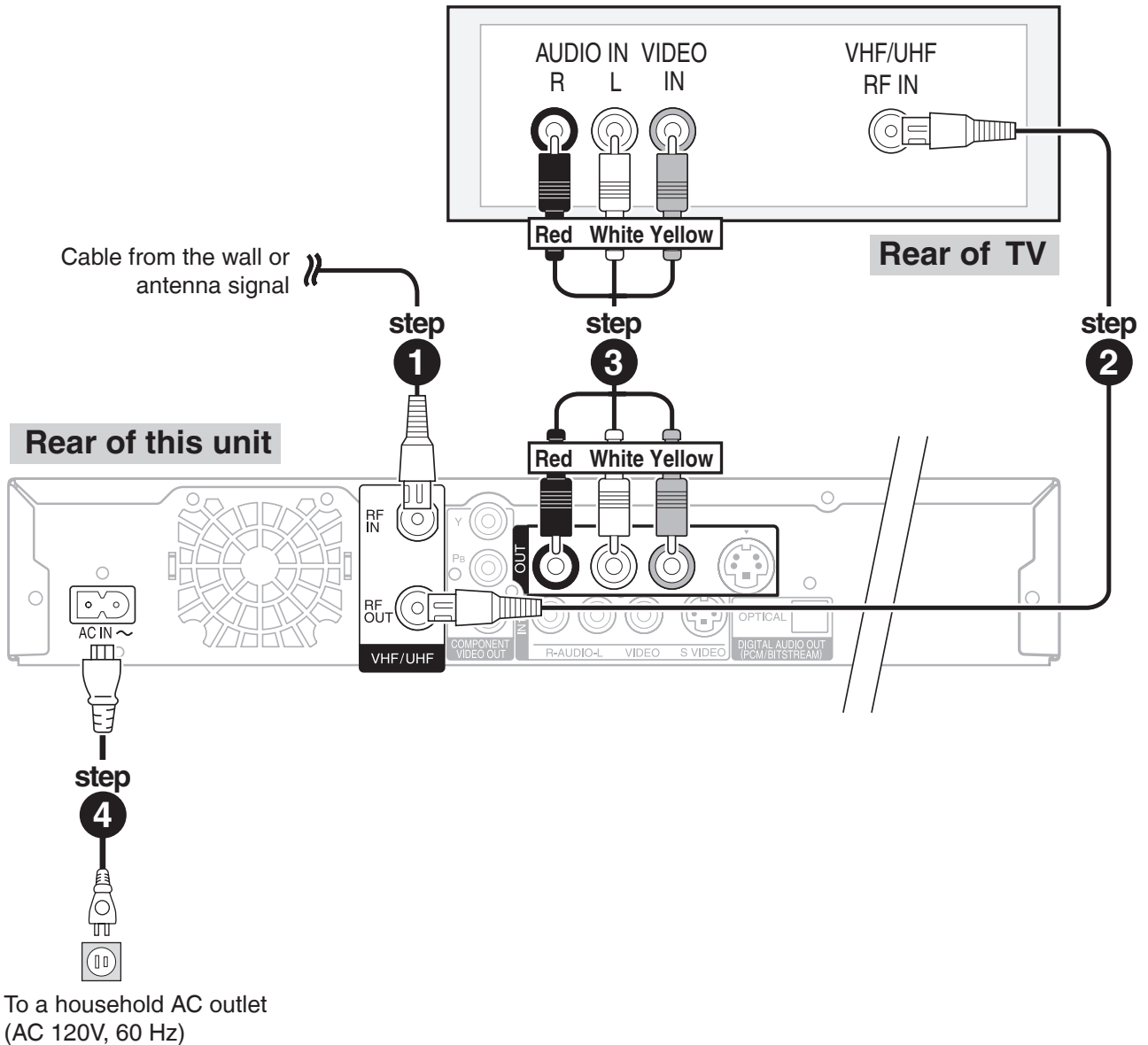

- ❶ Coaxial cable from the wall or antenna signal to the “RF IN” on the unit.
- ❷ Coaxial cable (*included*) from the “RF OUT” on the unit to the “VHF/UHF RF IN” on the TV.
- ❸ Audio/video cable (*included*) from the “OUT” on the unit to the “AV IN” on the TV.
- ❹ AC power supply cord (*included*) from the “AC IN~” on the unit to a household AC outlet.

**Note: The terminals on the rear of your TV and Cable Box may not appear as shown below. Please read terminal labels carefully to ensure correct connections.**

- Consult your cable service provider about the appropriate cable box to use.
- Additional coaxial cable and audio/video (AV) cable are required.
- If your TV does not have AV IN terminals (→ 41).

## Connecting to a Television and a Cable Box

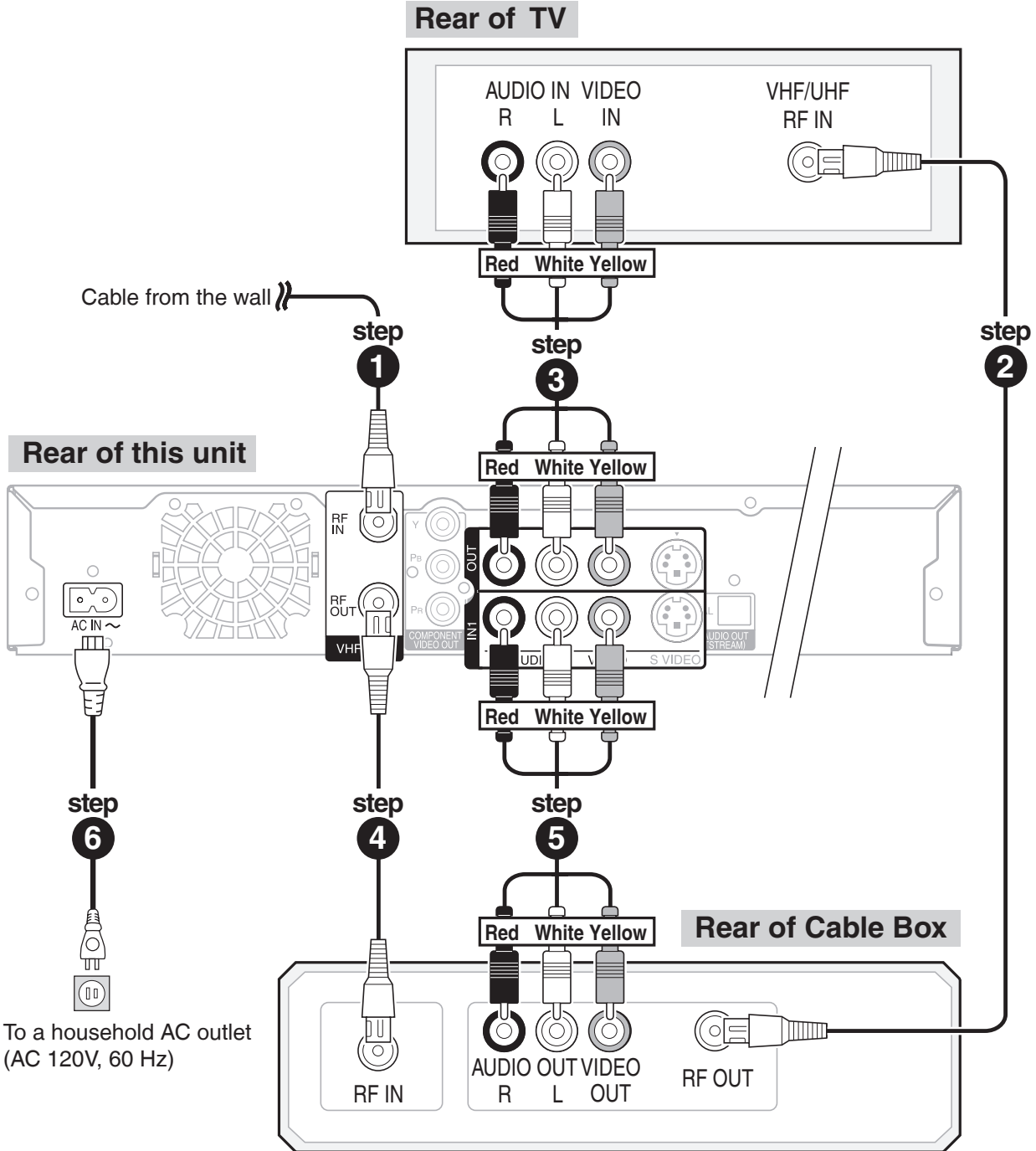

- 1 Coaxial cable from the wall to the “RF IN” on the unit.
- 2 Coaxial cable (included) from the “RF OUT” on the cable box to the “VHF/UHF RF IN” on the TV.
- 3 Audio/video cable (included) from the “OUT” on the unit to the “AV IN” on the TV.
- 4 Coaxial cable from the “RF OUT” on the unit to the “RF IN” on the cable box.
- 5 Audio/video cable from the “AV OUT” on the cable box to the “IN1” on the unit.
- 6 AC power supply cord (included) from the “AC IN~” on the unit to a household AC outlet.

# Basic Connection

**Note:** The terminals on the rear of your TV and Satellite Receiver may not appear as shown below. Please read terminal labels carefully to ensure correct connections.

- Additional coaxial cable and audio/video (AV) cable are required.
- If your TV does not have AV IN terminals (→ 41).

## Connecting to a Television and a Satellite Receiver

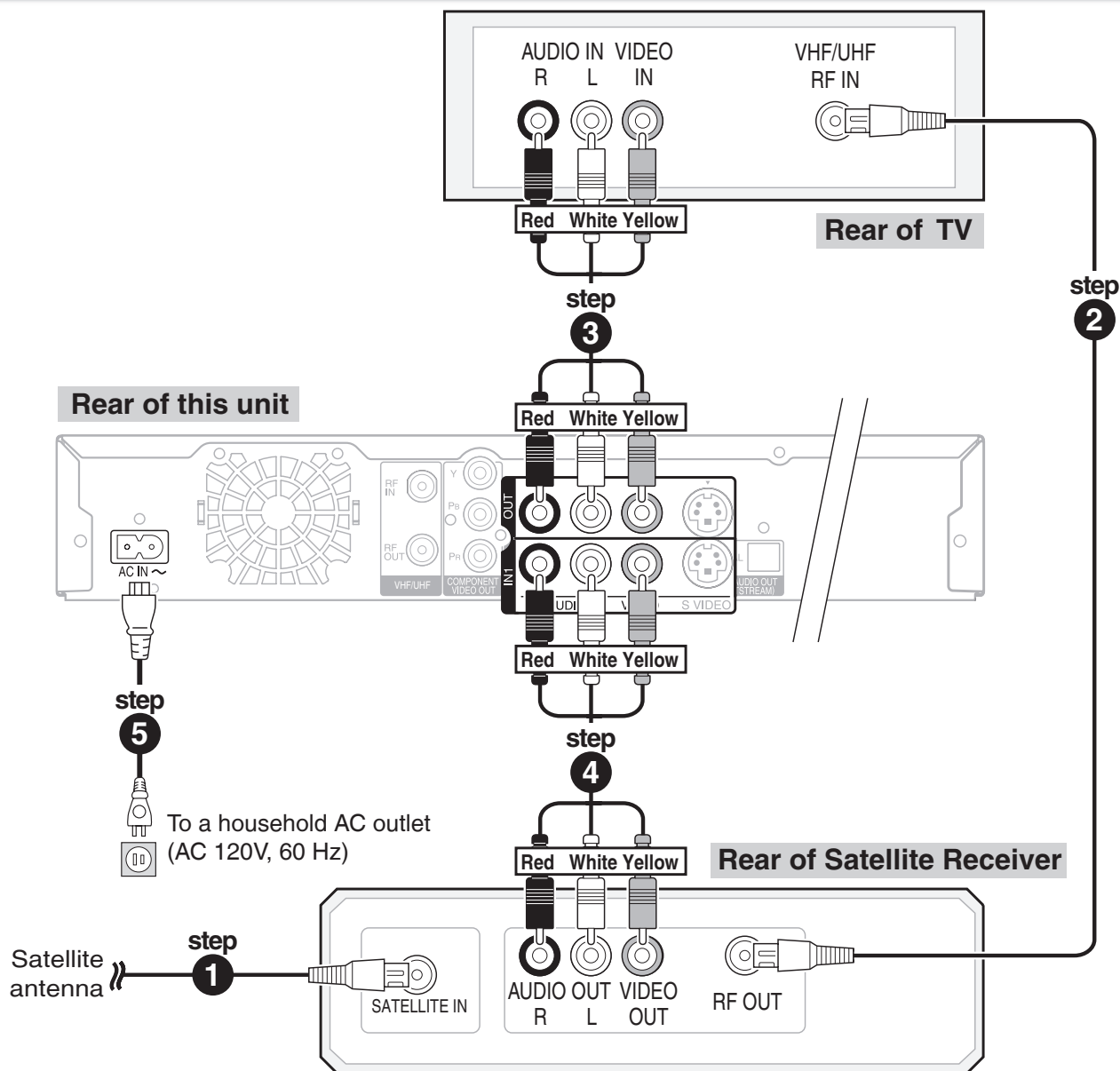

- 1 Coaxial cable from the satellite antenna to the “**SATELLITE IN**” on the satellite receiver.
- 2 Coaxial cable (*included*) from the “**RF OUT**” on the satellite receiver to the “**VHF/UHF RF IN**” on the TV.
- 3 Audio/video cable (*included*) from the “**OUT**” on the unit to the “**AV IN**” on the TV.
- 4 Audio/video cable from the “**AV OUT**” on the satellite receiver to the “**IN1**” on the unit.
- 5 AC power supply cord (*included*) from the “**AC IN~**” on the unit to a household AC outlet.



## Using an RF Modulator, if your Television does not have Audio/Video Terminals

### Connecting to a Television

Connect cables in steps **2** and **3** (same as those on page 38) as follows.

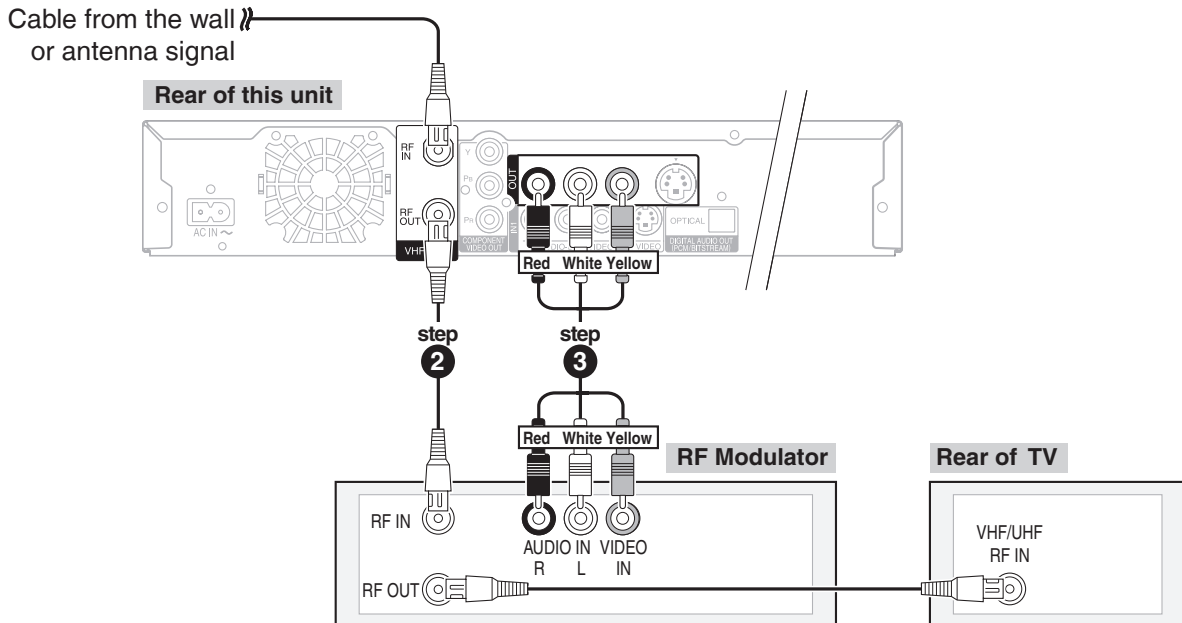

### Connecting to a Television with a Video Cassette Recorder or a Cable Box or Satellite Receiver

Connect cables in steps **2** and **3** (same as those on page 39 or 40) as follows.

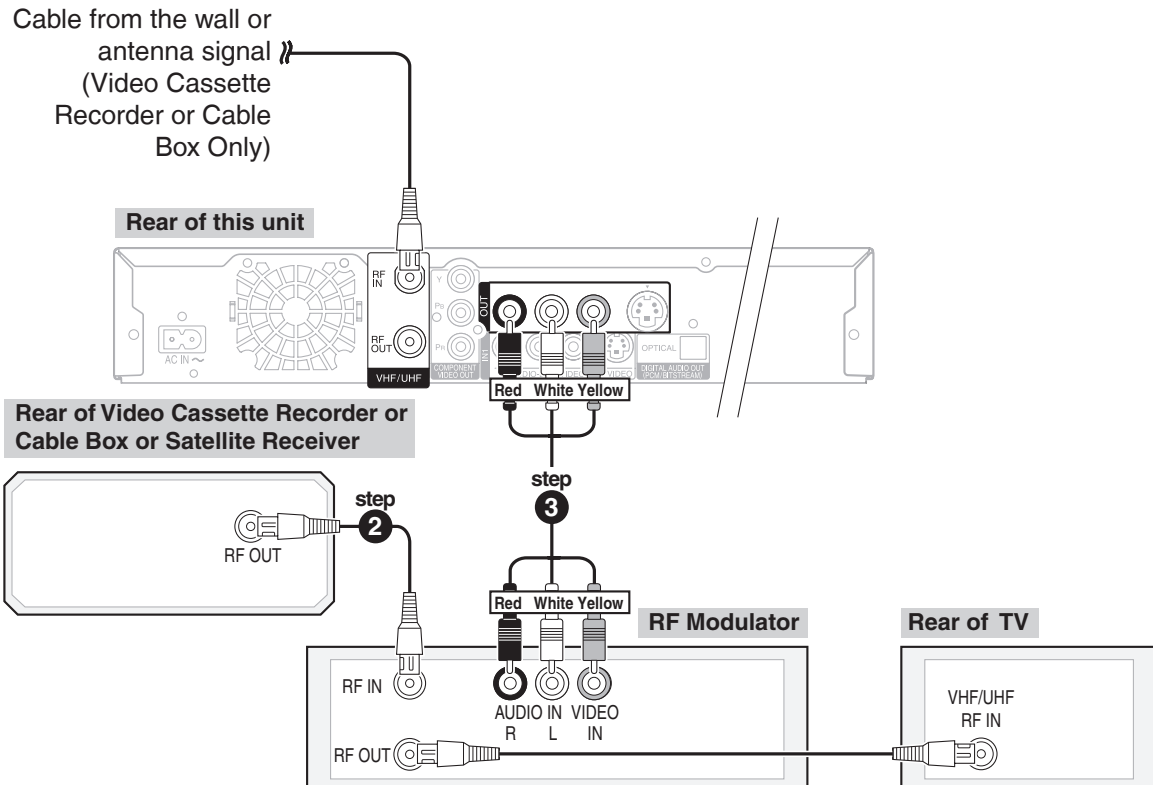

# Adding a Video Cassette Recorder (VCR)

- Additional coaxial cable and audio/video (AV) cable are required.

## Connecting to a Television and a VCR (No Cable Box or Satellite Receiver)

- 1 Perform step 1 on page 38.
- 2 Coaxial cable (included) from the “RF OUT” on the VCR to the “VHF/UHF RF IN” on the TV.
- 3 Audio/video cable (included) from the “OUT” on the unit to the “AV IN” on the TV.
- 4 Coaxial cable from the “RF OUT” on the unit to the “RF IN” on the VCR.
- 5 Audio/video cable from the “IN1” on the unit to the “AV OUT” on the VCR.
- 6 Perform step 4 on page 38.

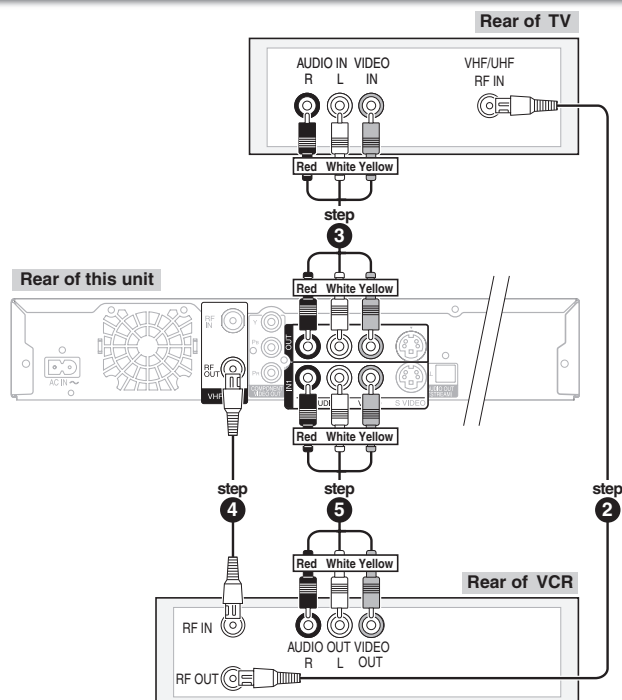

## Connecting to a Television, a Cable Box and a VCR

- 1 Perform step 1, 2, 3, 5 on page 39.
- 2 Coaxial cable from the “RF OUT” on the unit to the “RF IN” on the VCR.
- 3 Coaxial cable from the “RF OUT” on the VCR to the “RF IN” on the cable box.
- 4 Audio/video cable from the “AV OUT” on the VCR to the “IN2” on the unit.
- 5 Perform step 6 on page 39.

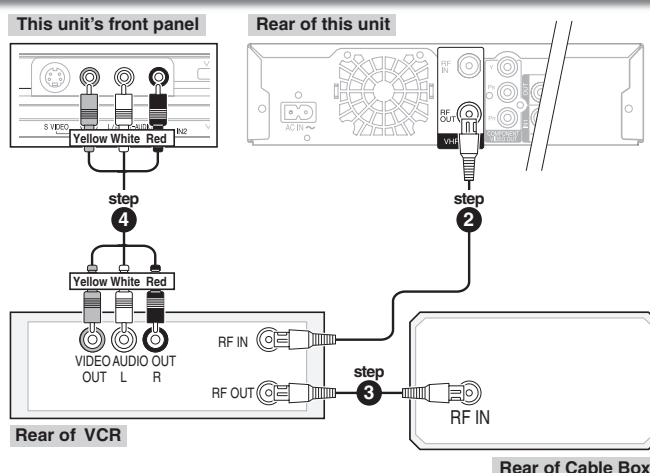

## Connecting to a Television, a Satellite Receiver and a VCR

- 1 Perform step 1, 3, 4 on page 40.
- 2 Coaxial cable (included) from the “RF OUT” on the satellite receiver to the “RF IN” on the VCR.
- 3 Coaxial cable from the “RF OUT” on the VCR to the “VHF/UHF RF IN” on the TV.
- 4 Audio/video cable from the “AV OUT” on the VCR to the “IN2” on the unit.
- 5 Perform step 5 on page 40.

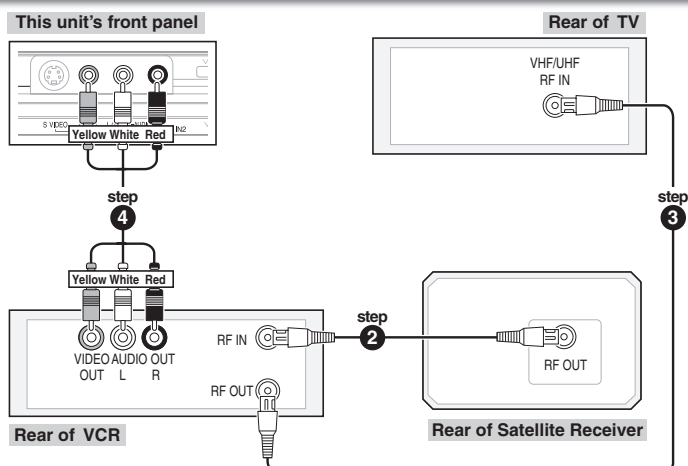

# Connection Options for Improved Playback Quality

- You can enjoy high-quality picture by using the following terminals for connection.

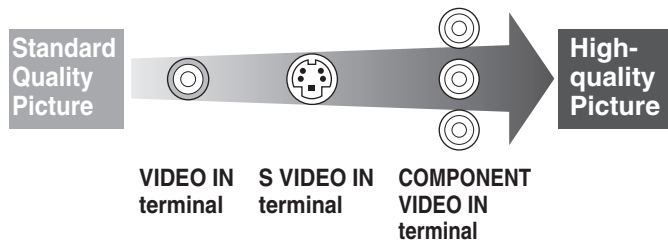

## Using an S Video Cable for Better Video (S Video Cable not included)

The S VIDEO OUT terminal achieves a more vivid picture than the VIDEO OUT terminal. (Actual results depend on the television).

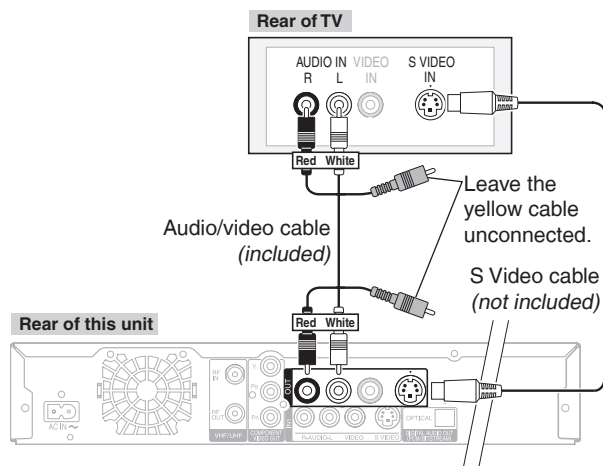

## Using Component Cables for Better Video (Component Video Cables not included)

The COMPONENT VIDEO OUT terminals on this unit can be used for either interlace or progressive output (→ 66) to provide a purer picture than the S VIDEO OUT terminal.

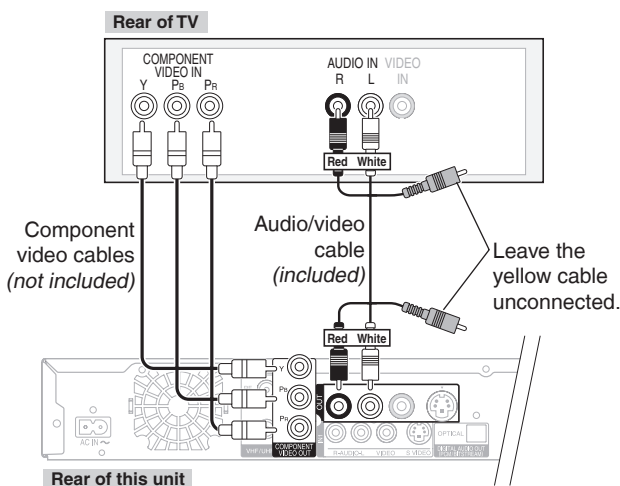

- You can enjoy better quality sound by changing the audio cable connection between this unit and your TV on pages 38 to 40 as follows.

## Using an Audio Cable for Better Sound

Use this connection to play sound through speakers connected to an amplifier or system component.

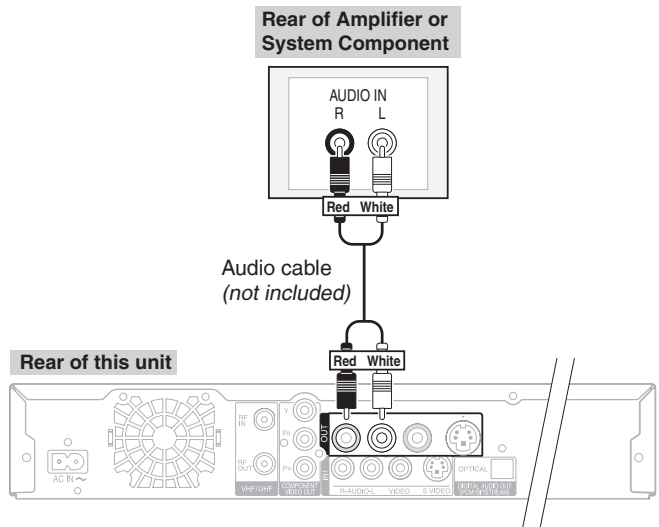

## Using an Optical Digital Audio Cable for Better Sound (Optical Digital Audio Cable not included)

This method allows you to enjoy multi-channel surround sound on DVD-Video.

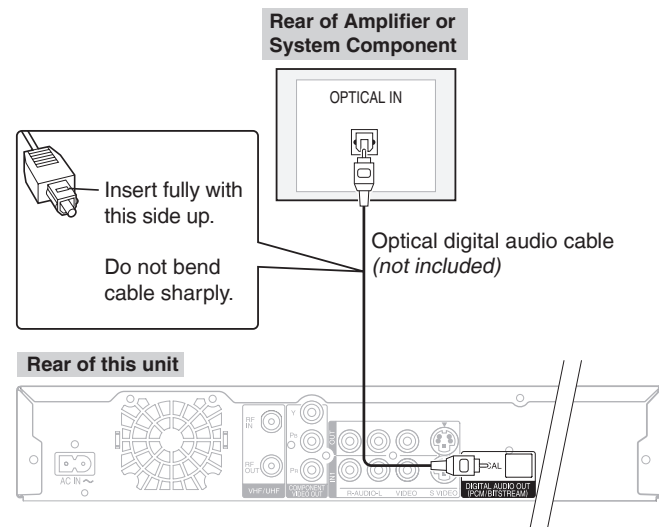

- Connect an amplifier or system component with a built-in decoder displaying these logo marks.



- Adjust settings in “Digital Audio Output” (→ 34).

## Notes

- You cannot use DTS Digital Surround decoders not meant for DVD.
- Before purchasing an optical digital audio cable, check the terminal shape of the equipment to be connected.

# Setting the Channels and Clock

## Preparation:

- Turn on the television and select the appropriate video input to suit the connections to this unit.
- These are the first settings you make upon buying the unit. You don't need to make these settings again.



- 1**  to turn the unit on.

- 2** Language:  
▲, ▼ to select, then 

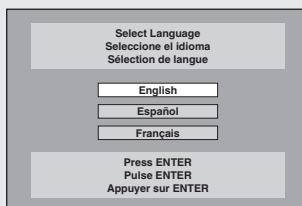

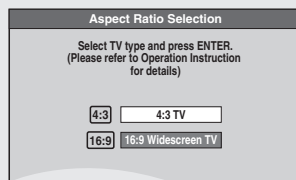

- 3** TV Aspect Ratio:  
▲, ▼ to select "4:3 TV" or "16:9 Widescreen TV" then

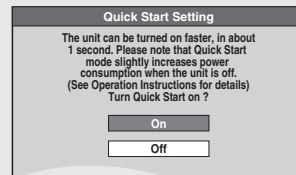

- When connecting to a 4:3 standard aspect TV: Select "4:3 TV".
- When connecting to a 16:9 widescreen TV: Select "16:9 Widescreen TV".

- 4** Quick Start Function:  
▲, ▼ to select "On" or "Off" then 



- 5** Automatic Clock and Channel Setting:  
▲, ▼ to select "Yes" or "No" then 

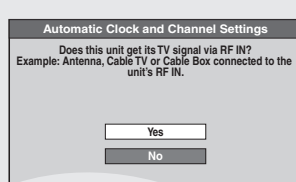

- When connecting the cable from the wall (cable TV or antenna) to the unit's RF IN: Select "Yes".  
The unit then displays the source selection screen (→ 45).
- When not connecting the cable from the wall (cable TV or antenna) to the unit's RF IN: Select "No".  
The unit then displays "Set Clock Manually" screen (→ 45, Manual Clock Setting).

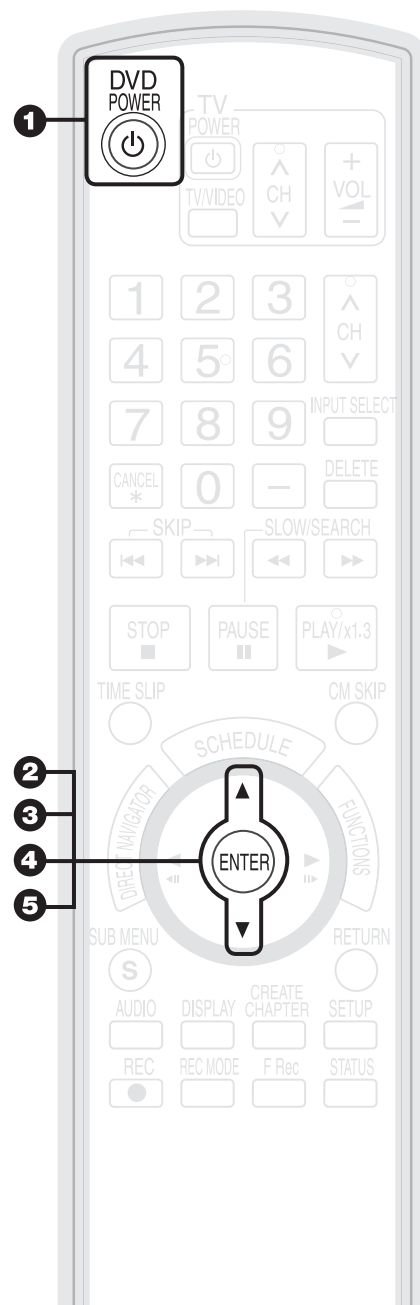

## Tips

- **"Quick Start" function (→ 32)**  
If you set Quick Start to on, you can start recording to DVD-RAM about 1 second after you press [DVD POWER] to turn the unit on and then sequentially press [REC].  
The following happens when you have selected "On".  
– Power consumption in standby mode increases because power is supplied to the unit.

**To return to the previous screen**  
Press [RETURN].

**6** The types of transmission:  
▲, ▼ to select “Antenna” or  
“Cable”, then

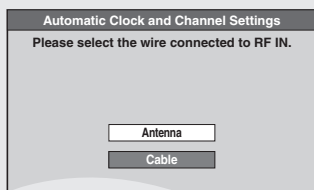

**7** to start automatic channel/  
clock setting.

**8** Confirm the time, then   
– DST (Daylight Saving Time) shows the  
summertime setting.  
– Time Zone shows the time difference from  
Greenwich Mean Time (GMT).

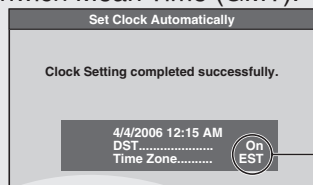

See “Notes”  
(→ right).

### Tips

- If the unit displays “No channels were found.”, turn off the unit and confirm the cable or antenna input is connected to the RF IN terminal. Restart the set up again (→ below).
- If “Auto Clock Setting is incomplete.” is displayed, press [ENTER] and set the clock manually (→ right).
- If the clock is not correct, set the clock with “Adjust Time Zone” (→ 47) or “Set Clock Manually” (→ 32).
- You can delete channels you don’t need after completing Auto Channel Setting (→ 46).

### Restarting the Auto-Setup (after relocation, for example)

1. When the unit is on and stopped, press and hold [CH ∨] and [CH ∧] on the main unit at the same time for about 5 seconds. The unit turns off.
2. Press [⏻ DVD POWER] to turn the unit on. (The signal source, and channel captions revert to their default values. All scheduled recordings are cleared.)

### To cancel in the middle Press [RETURN].

### Notes

- Conditions of the received channel may cause automatic channel/clock setting to take extra time.

### Manual Clock Setting

Perform steps 1–5 on page 44.

**6** ◀, ▶ to select the item you want  
to change.

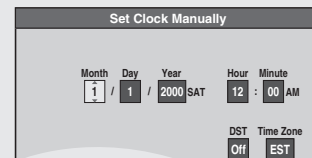

**7** ▲, ▼ to change the setting.  
– Repeat steps 6-7 to change other items.

**8** to confirm new date and  
time and to initiate the clock.

### Notes

- The automatic clock setting can take a few minutes.

#### • Time Zone

- EST (Eastern Standard Time) = GMT –5
- CST (Central Standard Time) = GMT –6
- MST (Mountain Standard Time) = GMT –7
- PST (Pacific Standard Time) = GMT –8
- AST (Alaska Standard Time) = GMT –9
- HST (Hawaii Standard Time) = GMT –10
- For other areas: xx hr

#### • DST (Daylight Saving Time)

If you select “On”, the clock is advanced one hour beginning at 2 a.m. on the second Sunday in March and ending at 2 a.m. on the first Sunday in November.  
Set the DST period manually when it varies according to regions (→ below).

#### To set the DST period manually

1. Press [SETUP].
2. ▲, ▼ to select “Setup” then ▶.
3. ▲, ▼ to select “Clock Settings” then press [ENTER].
4. ▲, ▼ to select “Set the time change dates for DST” then press [ENTER].
5. ▲, ▼, ◀, ▶ to set the “Month”, “Day”, “Hour”, and “Minute” then press [ENTER].

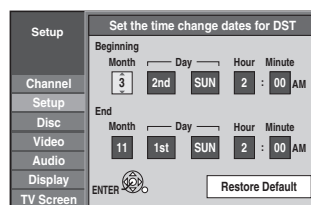

Restores Default  
Reinitializes the  
settings.

# Other Settings

## Setting Channel Captions

The captions you select or modify are used as channel names and displayed on the Direct Navigator screen.

With the unit stopped

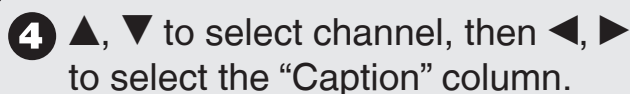
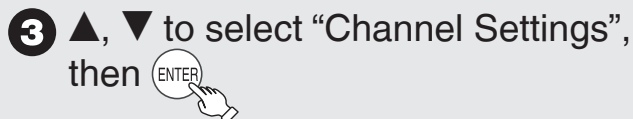



Setup	Channel Settings
Channel	Channel Caption Add/Del
Setup	2 --- Deleted
Disc	3 C003 Added
Video	4 CBS Added
Audio	4-1 KRON-SD Added
Display	4-2 KRON-HD Added
TV Screen	5 C005 Added
	6 --- Deleted
	7 --- Deleted
	8 --- Deleted
	9 C009 Added

### To select the caption:

- 5a** ▲, ▼ to select the caption.  
 – After selecting the “Channel” column with [◀, ▶], repeat steps 4-5a to set other channels.

### To modify the caption:

- 5b** 1.   
 2. ▲, ▼ to select a character, then ► to move to the next character.  
 – Repeat this step to enter other characters.  
 3.  to confirm changes.  
 – After selecting the “Channel” column with [◀, ▶], repeat steps 4-5b to set other channels.

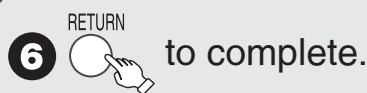

### Notes

- Available characters for channel captions  
 A-Z, a-z, 0-9, \_, -, (space)

## Adding and Deleting Channels

To add channels, delete undesired channels, or channels that have poor reception. Perform steps 1-3 of “Setting Channel Captions”.

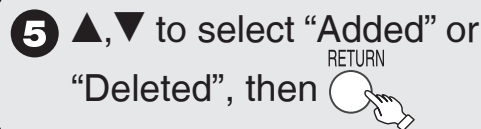
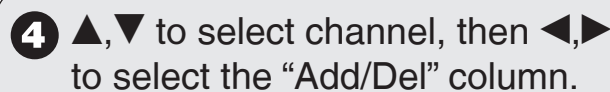

## Selecting Television Type

This setting does not need to be changed when connected to a 4:3 standard aspect TV that is not compatible with progressive output.

With the unit stopped



Setup	TV Type
Channel	4:3 TV
Setup	Aspect 4:3 & 480i (interface)
Disc	Aspect 4:3 & 480p (progressive)
Video	16:9 Widescreen TV
Audio	Aspect 16:9 & 480i (interface)
Display	Aspect 16:9 & 480p (progressive)
TV Screen	

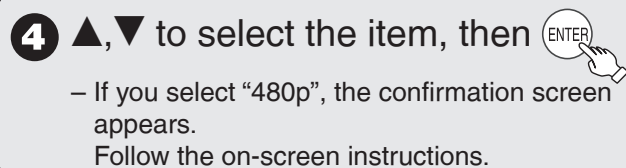

### Notes

- Aspect 4:3/16:9

4:3

16:9

4:3 standard aspect television 16:9 widescreen television

- **480p/480i**  
 Select “480p” if the television is compatible with progressive output. Select “480i” if the television is not compatible with progressive output or you are unsure about television compatibility.
- Digital programs broadcast in the 16:9 aspect ratio may appear with black bands at the edges of the screen on 4:3 aspect televisions. The bands are added to enable the correct aspect ratio to be shown.

### Tips

**To return to the previous screen**  
 Press [RETURN].

**To exit the screen**  
 Press [SETUP].

## Clock Settings

With the unit stopped

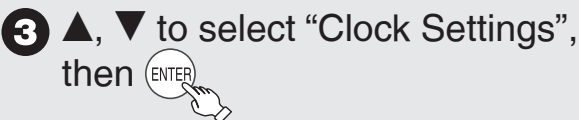
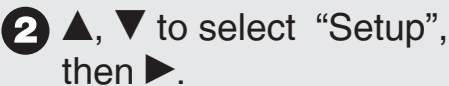

### Set Clock Automatically

Perform steps 1–3 of “Clock Settings”.

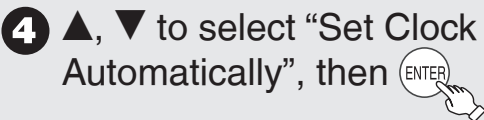

to start auto setting.

The following dialog appears when setting is complete.

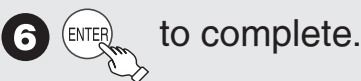
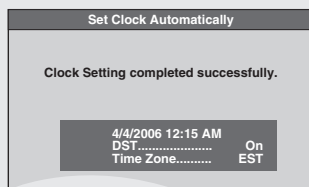

to complete.

## Notes

- This may take some time, up to a few hours in some cases.
- If the following message appears

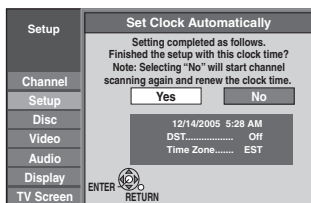

- If the time is correct, ◀ to select “Yes”, then [ENTER].
  - If you select “No”, auto setting starts again, then the above screen reappears. Repeat this step until the correct time appears.
- If the clock is not correct, set the clock with “Adjust Time Zone” (→ right) or “Set Clock Manually” (→ 32).



## Tips

### To cancel in the middle

Press [RETURN]. The unit then displays “Set Clock Manually” screen (→ 45, Manual Clock Setting).

### • Time Zone

Time Zone shows the time difference from Greenwich Mean Time (GMT).

EST (Eastern Standard Time)	= GMT -5
CST (Central Standard Time)	= GMT -6
MST (Mountain Standard Time)	= GMT -7
PST (Pacific Standard Time)	= GMT -8
AST (Alaska Standard Time)	= GMT -9
HST (Hawaii Standard Time)	= GMT -10
For other areas: xx hr	

### • DST (Daylight Saving Time)

If you select “On”, the clock is advanced one hour starting at 2 a.m. on the second Sunday in March and ending at 2 a.m. on the first Sunday in November.

Set the DST period manually when it varies according to regions (→ 45).

## Adjust Time Zone

Adjust the time zone (-1 or 1) if it was not set correctly with auto clock setting.

You can set this menu only after “Set Clock Automatically” is completed.

Perform steps 1–3 of “Clock Settings”.

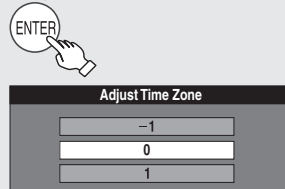

## Tips

### To return to the previous screen

Press [RETURN].

### To exit the screen

Press [SETUP].

## Automatic Off Timer

This determines how long the unit stays on when it's not being used. Default = 6 hours (then it switches to standby) To turn off the “Off Timer”, or to change the setting to 2 hours, see page 32.

# Other Settings

## Using the Unit's Remote Control to Operate the TV and the Set Top Box (Cable Box, Satellite Receiver, etc.)

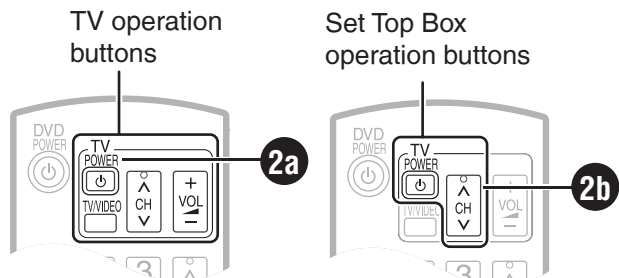

- 1 Point the remote control at the TV or Set Top Box.

### To set the code for the TV:

- 2a While pressing and holding , enter the code from the table right using the numbered buttons.

e.g., 0250: press [0] → [2] → [5] → [0]

### To set the code for the Set Top Box:

- 2b While pressing and holding , enter the code from the table right using the numbered buttons.

e.g., 1786: press [1] → [7] → [8] → [6]

- 3 Test the TV or Set Top Box functions of the remote control for operability.

- **To switch to the Set Top Box mode:**  
Press and hold [CH ^] and [RETURN] simultaneously for 5 seconds or longer.
- **To switch to the TV mode:**  
Press and hold [TV POWER] and [RETURN] simultaneously for 5 seconds or longer.
- If the functions do not work, repeat steps 1 to 3 using different codes, if available. Some TVs and Set Top Boxes may not be compatible with the unit's remote control.

## Remote Control Codes for the TV

Manufacturer	Code
Panasonic	0051 / 0055 / 0250 / 0650
Advent	0761 / 0783 / 0815 / 0817 / 0842
Akai	0030 / 0098 / 0672 / 0702 / 0812
America Action	0180
AOC	0003 / 0019 / 0030 / 0052 / 0137 / 0185
Apex	0748 / 0765 / 0767 / 0879
Audiovox	0003 / 0092 / 0180 / 0451 / 0623 / 0802 / 0875
Axion	1937
Bang & Olufsen	0620 / 1620
Broksonic	0003 / 0236 / 0463
Casio	0611 / 1205
Daewoo	0019 / 0039 / 0066 / 0067 / 0091 / 0092 / 0451 / 0623 / 0661 / 0672 / 1661
Emerson	0019 / 0038 / 0039 / 0154 / 0158 / 0171 / 0177 / 0178 / 0179 / 0180 / 0181 / 0182 / 0183 / 0185 / 0236 / 0270 / 0280 / 0282 / 0463 / 0623
Envision	0030 / 0813
Epson	0833 / 0840
Fisher	0154 / 0159
Fujitsu	0179 / 0186 / 0683 / 0809 / 0853
GE	0021 / 0027 / 0029 / 0047 / 0051 / 0055 / 0135 / 0138 / 0174 / 0178 / 0251 / 0279 / 0282 / 0451 / 0747 / 1347 / 1447
Go-Video	0886
Haier	0768 / 1034
Hannspree	1348 / 1351 / 1352
Hewlett Packard	1088 / 1089 / 1101 / 1494 / 1502
Hisense	0748
Hitachi	0016 / 0032 / 0038 / 0056 / 0095 / 0097 / 0145 / 0151 / 0173 / 0227 / 0279 / 0409 / 0413 / 1145
In Focus	0736 / 0738 / 0739 / 0741 / 0752 / 0759 / 0781 / 1164 / 1516
JVC	0036 / 0053 / 0069 / 0160 / 0169 / 0182 / 0731 / 1253
KLH	0765 / 0767
LG	0178 / 0317 / 0442 / 0457 / 0700 / 0856 / 1178 / 1265
Loewe	0136
Magnavox	0020 / 0024 / 0028 / 0030 / 0036 / 0054 / 0096 / 0179 / 0186 / 0187 / 0230 / 0386 / 0706 / 0802 / 1254 / 1454
Marantz	0030 / 0054 / 0444 / 0704 / 0854 / 0855 / 1154
Memorex	0016 / 0106 / 0150 / 0154 / 0178 / 0179 / 0463
Mitsubishi	0014 / 0019 / 0093 / 0098 / 0145 / 0150 / 0155 / 0178 / 0331 / 0358 / 0836 / 0868 / 1250
Norcent	0748 / 0824
Optoma	0887
Orion	0179 / 0236 / 0463 / 1463
Philips	0054 / 0690 / 1154 / 1454
Philips Magnavox	0020 / 0024 / 0028 / 0030 / 0036 / 0054 / 0096 / 0179 / 0186 / 0187 / 0230 / 0386 / 0690 / 0706 / 0802 / 1154 / 1254 / 1454
Pioneer	0038 / 0166 / 0172 / 0679 / 0866
Polaroid	0765 / 0865 / 1262 / 1276 / 1314 / 1316 / 1326 / 1327 / 1328 / 1341 / 1498 / 1523
Proscan	0047 / 0747 / 1347 / 1447
Proview	0835 / 1401 / 1498
RCA	0018 / 0019 / 0029 / 0038 / 0047 / 0090 / 0135 / 0174 / 0278 / 0679 / 0747 / 1047 / 1147 / 1247 / 1347 / 1447 / 1547
Runco	0017 / 0030 / 0251 / 0497 / 0603
Sampo	0030 / 0032 / 0039 / 0052 / 0100 / 0110 / 1755
Samsung	0019 / 0030 / 0032 / 0056 / 0060 / 0178 / 0329 / 0408 / 0427 / 0587 / 0702 / 0766 / 0812 / 0814 / 1060
Sansui	0463
Sanyo	0088 / 0107 / 0146 / 0154 / 0159 / 0232 / 0484 / 0799 / 0893
Sharp	0039 / 0093 / 0153 / 0157 / 0165 / 0220 / 0281 / 0386 / 0398 / 0491 / 0688 / 0689 / 0818 / 0851
Sony	0000 / 0011 / 0080 / 0111 / 0273 / 0353 / 0810 / 0834 / 0867 / 1100
Sva	0587 / 0748 / 0768 / 0865 / 0870 / 0871 / 0872



## Remote Control Codes for the TV (Continued)

Manufacturer	Code
Sylvania	0020 / 0028 / 0030 / 0054 / 0065 / 0096 / 0171 / 0381
Symphonic	0171 / 0180
Syntax-Brilliant	1007 / 1144 / 1240 / 1255 / 1257 / 1258 / 1331
Tatung	0003 / 0049 / 0055 / 0396 / 1756
Thomson	0209 / 0210 / 0047
Toshiba	0036 / 0060 / 0149 / 0154 / 0156 / 0650 / 0832 / 0845 / 1156 / 1256 / 1265 / 1356 / 1656 / 1704
Ultra Products	0391
Viewsonic	0857 / 0864 / 0885 / 1755
Westinghouse	0885 / 0889 / 0890 / 1282 / 1577
Yamaha	0019 / 0030 / 0769 / 0833 / 0839
Zenith	0016 / 0017 / 0092 / 0178 / 0463 / 1265

## Remote Control Codes for the Set Top Box:

### Cable Box

Manufacturer	Code
Panasonic	0000 / 0107
ABC	0003 / 0008
Americast	0899
Bell South	0899
Digeo	1187
Director	0476
General Instrument	0003 / 0276 / 0476 / 0810
GoldStar	0144
Hamlin	0009 / 0273
Jerrold	0003 / 0276 / 0476 / 0810
Memorex	0000
Motorola	1376 / 0276 / 0476 / 0810 / 1187
Pace	0008 / 0237 / 1877
Paragon	0000
Philips	0317 / 1305
Pioneer	0144 / 0533 / 0877 / 1877
Pulsar	0000
Quasar	0000
Regal	0273 / 0279
Runco	0000
Samsung	0144
Scientific Atlanta	0008 / 0477 / 0877 / 1877
Sony	1006
Starcom	0003
Supercable	0276
Torx	0003
Toshiba	0000
Zenith	0000 / 0525 / 0899

### Satellite Receiver

Manufacturer	Code
Panasonic	0152 / 0247 / 0701 / 1786
AlphaStar	0772
Chaparral	0216
Crossdigital	1109
DirecTV	0099 / 0247 / 0392 / 0566 / 0639 / 0724 / 0749 / 0819 / 1076 / 1108 / 1109 / 1142 / 1377 / 1392 / 1414 / 1442 / 1443 / 1444 / 1609 / 1639 / 1640 / 1749 / 1856
Dish Network System	0775 / 1005 / 1170 / 1505 / 1775
Dishpro	0775 / 1005 / 1505 / 1775
EchoStar	0775 / 1005 / 1170 / 1505 / 1775
Expressvu	0775 / 1775
GE	0392 / 0566
General Instrument	0869
GOI	0775 / 1775
Goodmans	1246
Hisense	1535
Hitachi	0819 / 1250
HTS	0775 / 1775
Hughes	0749 / 1442 / 1749
Hughes Network Systems	0749 / 1142 / 1442 / 1443 / 1444 / 1749

## Satellite Receiver (Continued)

Manufacturer	Code
iLo	1535
Janeil	0152
Jerrold	0869
JVC	0775 / 1170 / 1775
LG	1226 / 1414
Magnavox	0722 / 0724
Memorex	0724
Mitsubishi	0749
Motorola	0856 / 0869
NEC	1270
Next Level	0869
Paysat	0724
Philips	0099 / 0722 / 0724 / 0749 / 0819 / 1076 / 1142 / 1442 / 1749
Pioneer	1442
Proscan	0392 / 0566
Proton	1535
RadioShack	0869
RCA	0143 / 0392 / 0566 / 0855 / 1392
Samsung	1108 / 1109 / 1142 / 1276 / 1377 / 1442 / 1609
Sanyo	1219
Sony	0639 / 1639 / 1640
Star Choice	0869
Tivo	1142 / 1442 / 1443 / 1444
Toshiba	0749 / 0790 / 0819 / 1285 / 1749
UltimateTV	1392 / 1640
Uniden	0722 / 0724
US Digital	1535
USDTV	1535
Voom	0869
Zenith	1856

## Cable Box / Personal Video Recorder Combination

Manufacturer	Code
Americast	0899
Digeo	1187
General Instrument	0476 / 0810
Jerrold	0476 / 0810
Motorola	0476 / 0810 / 1187 / 1376
Pace	0237 / 1877
Pioneer	0877 / 1877
Scientific Atlanta	0877 / 1877
Sony	1006
Supercable	0276
Zenith	0899

## Digital Broadcast Satellite / Personal Video Recorder Combination

Manufacturer	Code
DirecTV	0099 / 0392 / 0639 / 1076 / 1142 / 1377 / 1392 / 1442 / 1443 / 1444 / 1640
Dish Network System	0775 / 1505
Dishpro	0775 / 1505
EchoStar	0775 / 1170 / 1505
Expressvu	0775
Hughes Network Systems	1142 / 1442 / 1443 / 1444
JVC	1170
Motorola	0869
Philips	1142 / 1442
Proscan	0392
RCA	1392
Samsung	1442
Sony	0639 / 1640
Star Choice	0869

# Control Reference Guide

## Remote Control

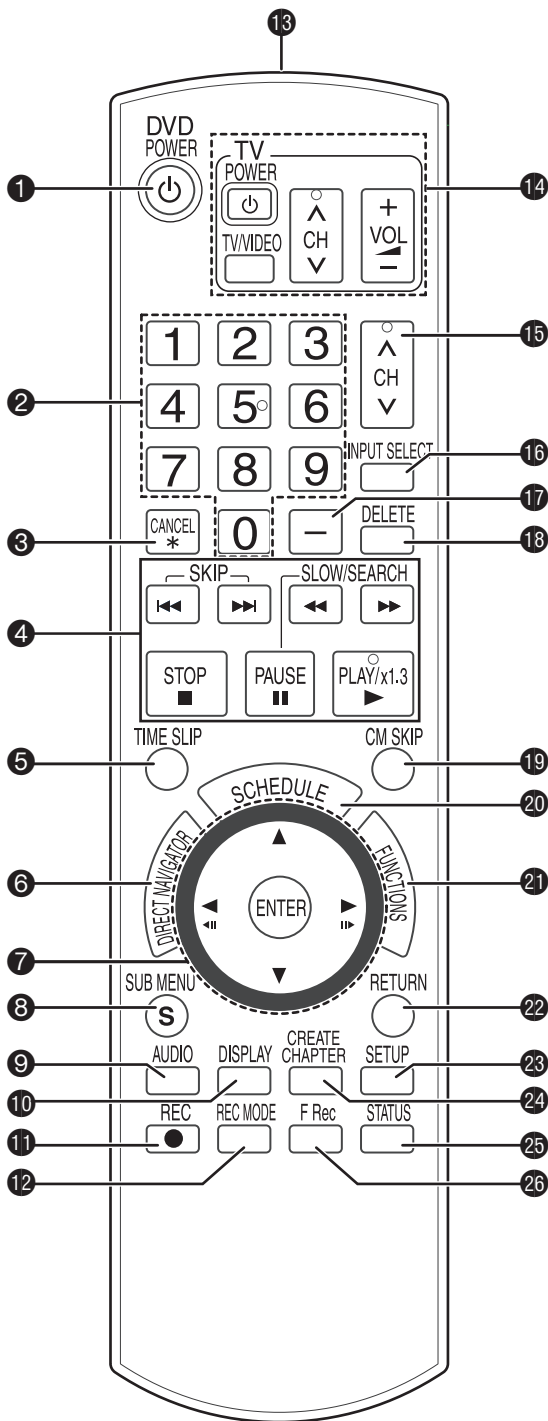

- 1 Turn the unit on or off..... (→ 6)
- 2 Select channels and recording numbers etc./  
Enter numbers ..... (→ 6)
- 3 Cancel
- 4 Basic operations for recording and play
- 5 Skip the specified time..... (→ 17)
- 6 Direct Navigator ..... (→ 16, 18)
- 7 Selection/Enter, Frame-by-frame..... (→ 6, 8, 17)
- 8 Show sub menu..... (→ 18, 20, 24)
- 9 Select audio ..... (→ 12, 17)
- 10 Show on-screen menu..... (→ 30)
- 11 Start recording ..... (→ 7)
- 12 Change recording mode..... (→ 7)
- 13 Transmission window
- 14 TV and Set Top Box operations ..... (→ 48)
- 15 Channel select ..... (→ 6)
- 16 Input select (TV, IN1, IN2, DV)..... (→ 22)
- 17 Sub channel access for digital broadcasts ..... (→ 6)
- 18 Delete items ..... (→ 9)
- 19 Skip 1 minute forward ..... (→ 17)
- 20 Show scheduled recording list..... (→ 8)
- 21 Show FUNCTIONS window ..... (→ below)
- 22 Return to previous screen
- 23 Show setup menu ..... (→ 32)
- 24 Create chapters ..... (→ 17)
- 25 Show status messages..... (→ 21)
- 26 Start Flexible Recording ..... (→ 13)

## FUNCTIONS Window

By using the FUNCTIONS window you may access the main functions quickly and easily.

With the unit stopped

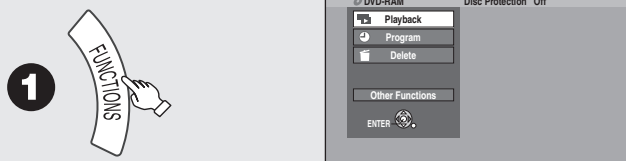

1

– Different discs display different functions.

2 ▲, ▼ to select a menu item,  
then ENTER

– If you select “Other Functions”, press [▲, ▼]  
to select a menu item and press [ENTER].

## Main Unit

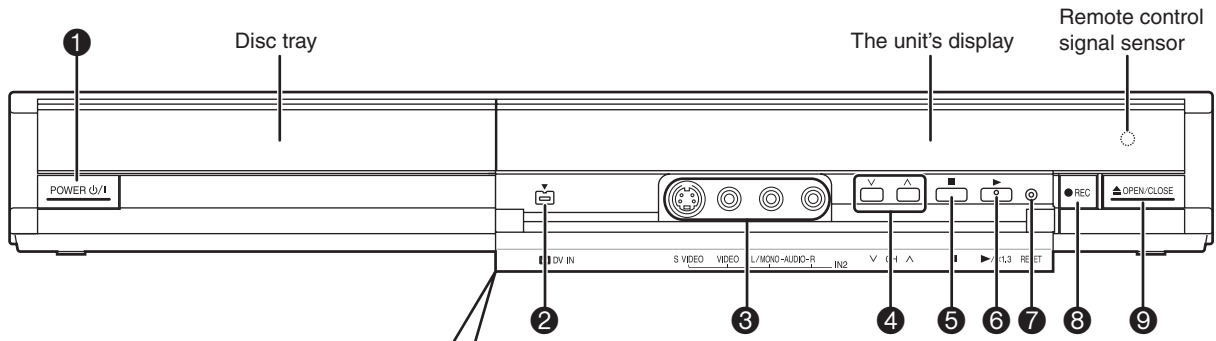

### Opening the front panel

Press down on the  part with your finger.

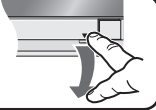

- |  |   |
|--|---|
| <p><b>1</b> POWER on/off button (POWER )..... (→ 6)</p> <ul style="list-style-type: none"> <li>• Press to switch the unit from on to standby mode or vice versa. In the standby mode, the unit is still consuming a small amount of power.</li> </ul> <p><b>2</b> Connector for a digital video (DV) camcorder..... (→ 23)</p> <p><b>3</b> IN2 input terminals (IN2) ..... (→ 22)</p> | <p><b>4</b> Channel Select ..... (→ 6)</p> <p><b>5</b> Stop button ..... (→ 6, 7)</p> <p><b>6</b> Play/X1.3 button ..... (→ 6)</p> <p><b>7</b> Reset button ..... (→ 55)</p> <p><b>8</b> Start recording..... (→ 7)</p> <p><b>9</b> Disc tray open/close button ..... (→ 6)</p> |
|--|---|



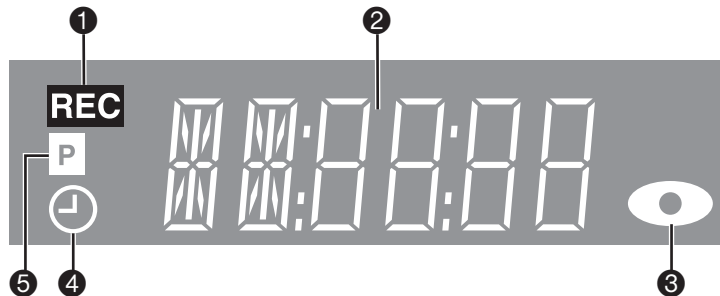

## The Unit's Display



- |  |   |
|--|---|
| <p><b>1</b> Recording indicator</p> <p><b>2</b> Main display section</p> <p><b>3</b> Disc indicator<br/>This indicator lights up when a disc that is supported by this unit is inserted.</p> | <p><b>4</b> Scheduled recording indicator (→ 8)<br/><b>On:</b><br/>When a scheduled recording program is registered and a recordable disc is inserted.<br/><b>Flashes:</b><br/>The scheduled recording indicator flashes when the unit cannot go to scheduled recording standby (e.g. there is no disc, etc). It does not flash if Quick Start is off.</p> <p><b>5</b> Progressive indicator<br/>This indicator lights up when you select "On" in "Progressive" (→ 31).</p> |
|--|---|

# Disc Handling

## Usable Discs for Recording and Playback

Disc type	Rewritable	Finalization Needed <sup>1</sup>	Recording 16:9 aspect picture <sup>2</sup>	Recording broadcasts that allow one copy (CPRM) (→ 10)	Standard symbol
DVD -RAM 	Yes	No	Yes	Yes	<b>RAM</b>
DVD -R 	No	Yes	No (4:3 aspect)	No	<b>-R</b> before finalization <b>DVD-V</b> after finalization
DVD -R DL 	No	Yes	No (4:3 aspect)	No	<b>-R DL</b> before finalization <b>DVD-V</b> after finalization
DVD -RW 	Yes	Yes	No (4:3 aspect)	No	<b>-RW(V)</b> before finalization <b>DVD-V</b> after finalization
+R	No	Yes	No (4:3 aspect)	No	<b>+R</b> before finalization <b>DVD-V</b> after finalization
+R DL	No	Yes	No (4:3 aspect)	No	<b>+R DL</b> before finalization <b>DVD-V</b> after finalization
+RW	Yes	No	No (4:3 aspect)	No	<b>+RW</b>

<sup>1</sup> Finalization needed for playback on other equipment (→ 29).

**RAM** can be played back on Panasonic DVD recorders and DVD-RAM compatible DVD players.

**-R DL** and **+R DL** can be played back only on equipment compatible with these discs.

<sup>2</sup> For further information (→ 10, Important Notes for Recording).

- Use of Panasonic discs is recommended.  
For available recording times for different discs under different recording modes, see “Recording Modes and Durations” on page 11.  
Formatting and/or recording/initializing constraints may prevent you from playing or recording certain discs.
- Please see specifications (→ 65) for compatible disc versions and recording speeds.





### Tips

- Visit Panasonic’s homepage for more information about DVDs.  
<http://www.panasonic.com/playDVD-R>
- Buy Discs from [www.panasonic.com](http://www.panasonic.com) and receive Special 20% Discount!  
Coupon Code: DVDMEDIA  
\*Offer good only in 50 United States.

- **RAM** will show an increase in available space whenever a recording has been erased.
- **-RW(V)** and **+RW** discs will only show an increase in available space when their last recording has been erased.
- **-R -R DL +R +R DL** The discs will show no increase in available space after deleting recordings.
- You may not be able to record depending on the condition of the discs and you may not be able to play them due to the condition of the recording.
- When recording MTS broadcast, refer to page10.

## Play-only Discs

Disc type	Standard symbol	Uses
DVD-Video 	<b>DVD-V</b>	High quality movie and music discs
DVD-RW (DVD Video Recording format) 	<b>-RW(VR)</b>	DVD-RW video recorded on another DVD recorder* <ul style="list-style-type: none"> <li>You can play programs that allow "One time only recording" if they have been recorded to a CPRM compatible disc.</li> <li>By formatting (→ 28) the disc, you can record to it in DVD-Video format.</li> <li>It may be necessary to finalize the disc on the equipment used for recording.</li> </ul>
Audio CD 	<b>CD</b>	<ul style="list-style-type: none"> <li>Recorded audio and music (including CD-R/RW*)</li> <li>CD-R* and CD-RW* with music recorded in MP3 (→ 54)</li> <li>Still pictures (JPEG) recorded on CD-R/RW*</li> </ul>

- \* Play may be impossible on some DVD-RW (DVD Video Recording format), CD-R or CD-RW discs due to the condition of the recording.
- You can play still pictures (JPEG), CD-DA and MP3 format data recorded on CD-R/RW. Close the session or finalize the disc after recording.
  - The producer of the disc can control how discs are played. So you may not always be able to control play as described in these operating instructions. Read the disc's instructions carefully.

## Discs that Cannot be Played

- 2.6/5.2 GB DVD-RAM, 12 cm (5")
- 3.95/4.7 GB DVD-R for Authoring
- DVD-R recorded in DVD Video Recording format
- DVD-R (DVD-Video format), DVD-R DL, DVD-RW (DVD-Video format), +R, +R DL recorded on another unit and not finalized (→ 66)
- PAL discs
- DVD-Video with a region number other than "1" or "ALL"
- Blu-ray, HD DVD
- DVD-Audio
- Video CD
- DVD-ROM, +R 8 cm (3"), CD-ROM, CDV, CD-G, Photo CD, CVD, SVCD, SACD, MV-Disc, PD, DivX Video Disc, etc.



### Notes

#### Note about using a DualDisc:

The digital audio content side of a DualDisc does not meet the technical specifications of the Compact Disc Digital Audio (CD-DA) format so play may not be possible.

## Inserting Discs

**1**  to open the tray.  
– Insert a disc.



Insert label-up.

**2**  to close the tray.



### Notes

- When using 8 cm (3") DVD-RAM or 8 cm (3") DVD-R, remove the disc from the cartridge.
- It is not possible to record or play continuously from one side of a double sided disc to the other. You will need to eject the disc and turn it over.

## Disc Care

**RAM** Use cartridges to protect them from scratches and dirt.

### Holding a disc

Handle discs by the edges to avoid inadvertently scratching or getting oil from your fingers on the disc. Do not touch the signal surface of discs (the shiny side).

### Cleaning discs

Discs are not indestructible and occasionally dirt or condensation may appear. Clean by gently wiping with a soft, dry lint-free cloth in a straight line from the center of the disc to the edge of the disc. Return discs to their cases when not in use; this helps to protect against scratches and dirt.

### Storing discs

Do not place or store discs in the following locations:

- Direct sunlight
- Very dusty or humid areas
- Near a heat source
- Places that undergo extreme shifts in temperature (condensation can occur)
- Where static electricity or electromagnetic waves occur

### Discs to avoid

- Discs that are not perfectly circular in shape
- Warped discs, which may not balance properly in your unit, causing improper operation or damage to the unit
- Cracked discs
- Discs with exposed adhesive (from removed stickers or labels, such as may occur with rental discs or improperly cared-for discs that were previously labeled or re-labeled)

# MP3s and Still Pictures (JPEG)

## MP3 File Information

Playable discs	<b>CD</b>
File format	MP3 Files must have the extension “.mp3” or “.MP3”.
Number of folders (groups)	Maximum number of folders (groups) recognizable: 99 folders (groups) (including the root folder)
Number of files (tracks)	Maximum number of files (tracks) recognizable: 999 files (tracks) (Total number for all the MP3, JPEG and other type of files.)
Bit rates	32 kbps to 320 kbps
Sampling frequency	16 kHz/22.05 kHz/24 kHz/ 32 kHz/44.1 kHz/48 kHz
ID3 tags	not compatible

- If there is a large amount of still picture data etc. within an MP3 file, play may not be possible.

## Still Picture (JPEG) Information

Playable discs	<b>CD</b>
File format	JPEG Files must have the extension “.jpg” or “.JPG”.
Number of pixels	between 34×34 and 6144×4096 (Sub sampling is 4:2:2 or 4:2:0)
Number of folders	Maximum number of folders recognizable: 99 folders (including the root folder)
Number of files	Maximum number of files recognizable: 999 files (Total number for all the MP3, JPEG and other type of files.)
MOTION JPEG not compatible	



## Notes



- Compatible formats: ISO9660 level 1 or 2 (except for extended formats) and Joliet
- This unit is compatible with multi-session; however, reading or play of the disc may take time if there are a lot of sessions.
- Operation may take time to complete when there are many files (tracks) and/or folders (groups); some files (tracks) may not display or be playable.
- Images recorded at a very high resolution may take a long time to display.
- English alphabetical characters and Arabic numerals are displayed correctly. Other characters may not display correctly.
- The display order on this unit may differ from how the order is displayed on a computer.
- Depending on how you create the disc (writing software), files (tracks) and folders (groups) may not play in the order you number them.
- This unit is not compatible with packet-write format.
- Depending on the recording conditions, the disc may not play.



## Tips



You can play MP3s and still pictures (JPEG) on this unit by making folders as shown below. Depending on how you create the disc (writing software), play may not be in the order you number the folders.

How to structure MP3 folders  
Prefix with 3-digit numbers in the order you want to play them.

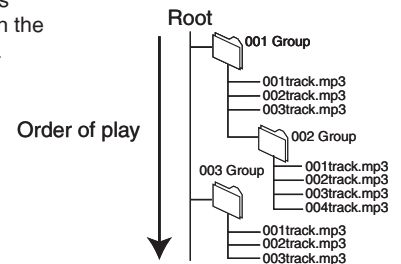

Structure of still pictures (JPEG)  
Files inside a folder are displayed in the order they were updated or taken.

- When the highest level folders are “DCIM” folders, they are displayed first on the tree.

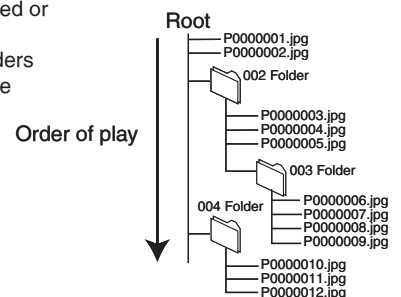

# Troubleshooting Guide

## If the Antenna Connector Doesn't Match

Use one of the following connections to suit the antenna lead to the unit's RF IN terminal, and the 75 Ω coaxial cable to the antenna terminals on your TV or other equipment. Refer to the other equipment's operating instructions for more information.

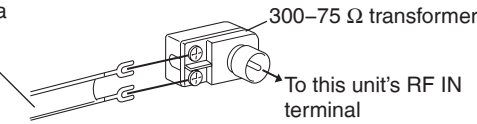
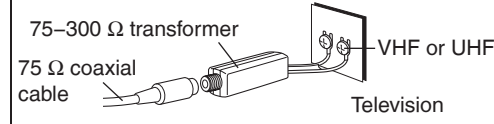
Type	This unit	Other equipment (television etc.)
A twin lead	from the antenna (Flat) Twin lead 300 Ω cable  300–75 Ω transformer To this unit's RF IN terminal	75–300 Ω transformer 75 Ω coaxial cable  VHF or UHF Television

## When Other Panasonic Products Respond to this Remote Control

Use this function to synchronize the codes for the remote control and the main unit when there are other Panasonic products close to your unit.

With the unit stopped

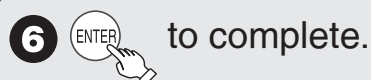
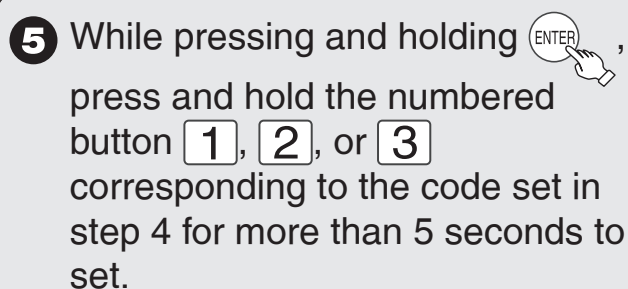
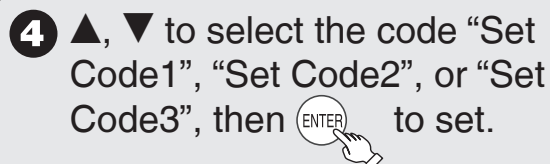
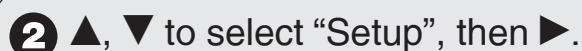

When the following indicator appears on the unit's display



– Change the code on the remote control to match the code displayed for the main unit (→ step 5).



## Tips

**To return to the previous screen**

Press [RETURN].

**To exit the screen**

Press [SETUP].

## To Reset This Unit

To reset the channel information and the clock settings

On the main unit

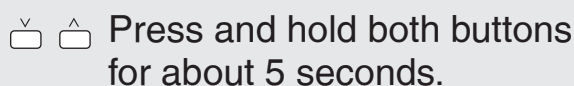

To reset the ratings level settings

You can reset both parental rating (→ 36) and DVD-Video rating (→ 33).

With the unit stopped

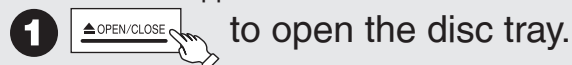

On the main unit

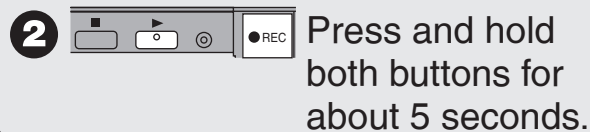

To restore the unit if it freezes

On the main unit

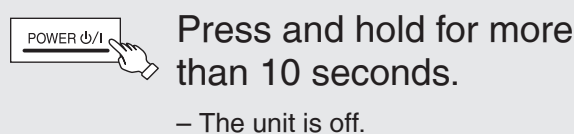

or

On the main unit

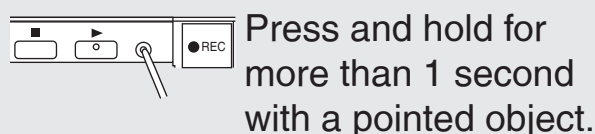

# Troubleshooting Guide

Before requesting service, make the following checks. If you are in doubt about some of the check points, or if the remedies indicated in the chart do not solve the problem, refer to “Customer Services Directory” on page 67.

## The following does not indicate a problem with the unit:

- Regular disc rotating sound.
- Poor reception due to atmospheric conditions.
- Image disturbance during search.
- Periodic interruptions to the reception due to satellite broadcasting breaks.
- Operations not working due to a poor-quality disc. (Try again using a Panasonic disc.)
- The unit freezing due to the activation of one of its safety devices (→ 55, To restore the unit if it freezes).

## General Issues

### Power

Page

No power.	<ul style="list-style-type: none"> <li>• Insert the AC power supply cord securely into a known active AC outlet.</li> </ul>	38 to 40
The unit switches to standby mode.	<ul style="list-style-type: none"> <li>• This is a power saving feature. Change “Off Timer” in the Setup menu to “Off” to always keep the unit on.</li> <li>• One of the unit’s safety devices is activated. Press [POWER <math>\phi</math>/I] on the main unit to turn the unit on.</li> </ul>	32 –

## General Issues

### Displays

Page

The display is dim.	<ul style="list-style-type: none"> <li>• Change “Front Display” in the Setup menu.</li> </ul>	34
“12:00A” is flashing on the unit’s display.	<ul style="list-style-type: none"> <li>• Set the clock.</li> </ul>	32, 47
The recording time display, and the displayed recording times of MP3s are different from the actual time.	<ul style="list-style-type: none"> <li>• Times shown may disagree with actual times.</li> <li>• <b>-R -R DL +R +R DL</b> The remaining capacity does not increase even if recordings are deleted.</li> <li>• Available space on a DVD-RW (DVD-Video format) or +RW disc increases when you delete the last recording (space may increase slightly when you delete other recordings).</li> <li>• If you record or edit about 200 times or more, the remaining capacity of DVD-R, DVD-R DL, +R, and +R DL is reduced and then recording or editing may be disabled (for the second layer on DVD-R DL and +R DL, this happens after about 60 times).</li> <li>• The time during searching may not be displayed accurately.</li> </ul>	– – – – –
Compared to the actual recorded time, the elapsed time displayed is less.	<ul style="list-style-type: none"> <li>• The displayed recording/play time is converted from the number of frames at 29.97 frames (equal to 0.999 seconds) to one second. There will be a slight difference between the time displayed and the actual elapsed time (e.g., actual one-hour elapsed time may display as approximately 59 minutes 56 seconds). This does not affect the recording.</li> </ul>	–



Cannot operate the TV or Set Top Box with the unit's remote control.	<ul style="list-style-type: none"> <li>• Change the manufacturer code on the remote control.</li> <li>• Select TV or Set Top Box mode on the remote control.</li> </ul>	48 48
The remote control doesn't work.	<ul style="list-style-type: none"> <li>• The remote control code is wrong. Change to the correct code.</li> <li>• The batteries are depleted. Replace them with new ones.</li> <li>• Point the remote control at the remote control sensor on the main unit.</li> <li>• Remove obstacles between the remote control and main unit.</li> <li>• Remove dust from the transmission window and the unit's sensor.</li> <li>• Colored glass may obstruct the signal reception/transmission.</li> <li>• Don't place the signal sensor in direct sunlight or in areas that may be subject to sun exposure.</li> <li>• It may be necessary to set the code on the remote control again after changing the batteries.</li> <li>• It may be necessary to set the manufacturer code again after changing the batteries.</li> </ul>	55 5 5 – – – – 55 48
The unit is on but cannot be operated.	<ul style="list-style-type: none"> <li>• Some operations are prohibited by the disc.</li> <li>• The unit is warm ("U59" appears on the unit's display). Wait until "U59" disappears.</li> <li>• One of the unit's safety devices may have been activated. Reset the unit as follows: Press [POWER <math>\odot</math>/I] on the main unit to switch to off. If the unit doesn't switch to off, reset the unit (<math>\rightarrow</math> 55, "To restore the unit if it freezes").</li> </ul>	– – –
"U88" is displayed and the disc cannot be ejected.	<ul style="list-style-type: none"> <li>• The unit is carrying out the recovery process. Do the following to eject the disc: (1) Press [POWER <math>\odot</math>/I] on the main unit to switch to off. If the unit doesn't switch to off, reset the unit (<math>\rightarrow</math> 55, "To restore the unit if it freezes"). (2) While the unit is off, press and hold [■] and [CH ^] on the main unit at the same time for about 5 seconds. (Ejection may take extra time depending on discs.) The disc may be defective. Try another disc.</li> </ul>	–
Cannot eject a disc.	<ul style="list-style-type: none"> <li>• The unit is recording.</li> <li>• The unit may have a problem. Eject the disc as in (2) above.</li> </ul>	– –
Startup is slow.	<ul style="list-style-type: none"> <li>• Startup takes time in the following situations: – A disc other than a DVD-RAM is inserted. – The clock is not set. – Immediately after a power failure or the AC power supply cord is connected.</li> </ul>	–
A password screen appears and you are unable to view or record.	<ul style="list-style-type: none"> <li>• If the television starts receiving a broadcast with the set rating information, a password screen appears and you will be unable to view or record. Enter your password to continue.</li> </ul>	36
Time is incorrect after using Auto Clock Setting.	<ul style="list-style-type: none"> <li>• Try again. If the time is still incorrect, set the clock manually (<math>\rightarrow</math> 32).</li> </ul>	47

# Troubleshooting Guide

Playback Issues	Picture	Page
TV reception worsens after connecting the unit.	<ul style="list-style-type: none"> <li>This can occur because the signals are being divided between the unit and other equipment. It can be solved by using a signal booster, available from electronics retailers.</li> </ul>	–
The images from the unit do not appear on the TV. Picture is distorted.	<ul style="list-style-type: none"> <li>Make sure recorder is connected to an appropriate AV input of the TV.</li> <li>Make sure the TV's input setting (e.g., VIDEO 1) is correct.</li> <li>The TV isn't compatible with progressive signals. Press and hold [* CANCEL] for about 5 seconds. The setting will change to interlace.</li> </ul>	38 to 40 – –
Status messages do not appear.	<ul style="list-style-type: none"> <li>Select "Automatic" in "Status Messages" in the Setup menu.</li> </ul>	34
The black background does not appear.	<ul style="list-style-type: none"> <li>Select "On" in "Black Background (Analog)" in the Setup menu.</li> </ul>	34
The 4:3 aspect ratio picture expands left and right. Screen size is wrong.	<ul style="list-style-type: none"> <li>Use the TV to change the aspect. If your TV does not have that function, set "Progressive" in the Video menu to "Off".</li> <li>Check the settings for "TV Type", "4:3 TV settings for DVD-Video", or "4:3 TV settings for DVD-RAM" in the Setup menu.</li> </ul>	31 34
There is a lot of after-images when playing video.	<ul style="list-style-type: none"> <li>Set "DNR" in the Video menu to "Off".</li> </ul>	31
When playing DVD-Video using progressive output, one part of the picture momentarily appears to be doubled up.	<ul style="list-style-type: none"> <li>Set "Progressive" in the Video menu to "Off". This problem is caused by the editing method or material used on DVD-Video, but should be corrected if you use interlaced output.</li> </ul>	31
There is no apparent change in picture quality when making adjustments in the Video menu using the on-screen menus.	<ul style="list-style-type: none"> <li>The effect cannot be seen with certain types of video.</li> </ul>	–

Playback Issues	Sound	Page
No sound. Low volume. Distorted sound. Cannot hear the desired audio type.	<ul style="list-style-type: none"> <li>Check the connections and the "Digital Audio Output" settings. Check the input mode on the amplifier if you have connected one.</li> <li>Check audio/video (AV) cables.</li> <li>Check if TV is muted.</li> <li>Check if amplifier is muted.</li> <li>Press [AUDIO] to select the audio.</li> <li>Sound is not output while fast-forwarding during chasing playback and simultaneous record and playback.</li> <li>Set "V.Surround Sound" in the Audio menu to "Off" in the following cases: <ul style="list-style-type: none"> <li>When using discs that do not have surround sound effects, such as Karaoke discs</li> <li>When playing analog MTS broadcast recordings</li> </ul> </li> <li>The sound effects will not work when the bitstream signal is output from the DIGITAL AUDIO OUT terminal.</li> </ul>	34, 38 to 43 38 to 43 – – 17 – 31 –
Cannot switch audio.	<ul style="list-style-type: none"> <li>You cannot change the audio type when a DVD-R, DVD-R DL, DVD-RW (DVD-Video format), +R, +R DL, or +RW disc is in the disc tray.</li> <li>You cannot change the audio type when playing a recording of an analog MTS broadcast on a DVD-R, DVD-R DL, DVD-RW (DVD-Video format), +R, +R DL or +RW disc. You can select "Main" or "Secondary Audio Program (SAP)" in "Multi-channel TV Sound (Analog)" in the Setup menu before recording.</li> <li>Only one language channel is recorded from digital MTS broadcasts, so you will be unable to change languages during playback.</li> <li>You have used a digital connection. Set "Dolby Digital" to "PCM" or connect using audio cables (analog connection).</li> <li>There are discs whose audio cannot be changed due to how the disc was created.</li> </ul>	– 12 12 34, 43 –

## Playback Issues

## Operation

Page

Play fails to start even when [▶ PLAY] is pressed. Play starts but then stops immediately.	<ul style="list-style-type: none"> <li>• Insert the disc correctly with the label facing up.</li> <li>• Ensure disc is for the correct DVD-Video region number, and is not defective.</li> <li>• The disc is dirty.</li> <li>• You tried to play a blank disc or a disc that is unplayable on the unit.</li> <li>• When recording to DVD-RAM using EP (8H) mode, play may not be possible on DVD players that are compatible with DVD-RAM. In this case use EP (6H) mode.</li> <li>• You cannot play discs during DV automatic recording.</li> </ul>	<p>–</p> <p>Cover, 53</p> <p>53</p> <p>53, 54</p> <p>33</p> <p>–</p>
Audio and video momentarily pause.	<ul style="list-style-type: none"> <li>• This occurs between playlist chapters.</li> <li>• This occurs as scenes change during Quick View.</li> <li>• <b>-R DL +R DL</b> Images and audio may be interrupted momentarily when play reaches the point where the recording passes from the first layer to the second.</li> </ul>	<p>–</p> <p>–</p> <p>10</p>
DVD-Video is not played.	<ul style="list-style-type: none"> <li>• You have set a ratings level to limit DVD-Video play. Change this setting.</li> </ul>	33
Alternative sound track and subtitles cannot be selected.	<ul style="list-style-type: none"> <li>• The languages are not recorded on the disc.</li> <li>• You may have to use the disc's own menus to select languages and audio tracks.</li> </ul>	<p>–</p> <p>16</p>
No subtitles.	<ul style="list-style-type: none"> <li>• When progressive output is on, TV's closed captions cannot be displayed. Go to the Setup menu and turn this unit's closed captions on.</li> <li>• Subtitles are not recorded on the disc.</li> <li>• Set "Subtitle" in the Disc menu to "On".</li> </ul>	<p>35</p> <p>–</p> <p>30</p>
Angle cannot be changed.	<ul style="list-style-type: none"> <li>• This function depends on software availability. Angles can only be changed during scenes where different angles are recorded.</li> </ul>	–
You have forgotten your ratings password.	<ul style="list-style-type: none"> <li>• With the tray open, press and hold [● REC] and [▶] on the main unit simultaneously for about 5 or more seconds.</li> </ul>	55
Quick View does not work.	<ul style="list-style-type: none"> <li>• This does not work when audio is other than Dolby Digital.</li> <li>• This does not work while recording in XP or FR mode.</li> </ul>	<p>–</p> <p>–</p>
The resume play function does not work.	<ul style="list-style-type: none"> <li>• Memorized positions are canceled when the unit is turned off or when the tray is opened.</li> </ul>	–

## Recording Issues

## Recording / Scheduled recording / External input

Page

Cannot record.	<ul style="list-style-type: none"> <li>• You haven't inserted a disc or the disc you inserted cannot be recorded on. Insert a disc the unit can record onto.</li> </ul>	52
	<ul style="list-style-type: none"> <li>• <b>RAM -RW(V) +RW</b> The disc is unformatted. Format the disc.</li> </ul>	28
	<ul style="list-style-type: none"> <li>• The write-protect tab on the cartridge is set to "PROTECT" or the disc is protected with the "DVD Management" settings.</li> </ul>	27
	<ul style="list-style-type: none"> <li>• Some programs have limitations on the number of times they can be recorded (CPRM).</li> </ul>	52, 66
	<ul style="list-style-type: none"> <li>• The disc is full or nearly full. Delete unneeded recordings or use another disc.</li> </ul>	9, 24
	<ul style="list-style-type: none"> <li>• You cannot record on finalized DVD-R, DVD-R DL, DVD-RW (DVD-Video format), +R, +R DL, or DVD-RW (DVD Video Recording format) discs.</li> </ul>	–
	<ul style="list-style-type: none"> <li>• If you repeatedly insert discs or turn the unit on and off about 50 times or more, the recording or editing of DVD-R, DVD-R DL, DVD-RW (DVD-Video format), +R, +R DL, and +RW discs may be disabled.</li> </ul>	–
	<ul style="list-style-type: none"> <li>• A DVD-R, DVD-R DL, DVD-RW (DVD-Video format), +R, +R DL, or +RW disc recorded on the unit may not be recordable on other Panasonic DVD recorders.</li> </ul>	–
	<ul style="list-style-type: none"> <li>• The broadcast you are trying to record is copy-protected.</li> </ul>	–

# Troubleshooting Guide

Recording Issues	Recording / Scheduled recording / External input (Continued)	Page
Recording does not stop even when [■ STOP] is pressed.	<ul style="list-style-type: none"> <li>If you start recording immediately after turning on the unit while “Quick Start” is set to “On”, you cannot stop recording for a few seconds.</li> </ul>	32
Scheduled recording does not work properly.	<ul style="list-style-type: none"> <li>The scheduled recording program is incorrect or different scheduled recording times overlap. Correct the program.</li> </ul>	15
	<ul style="list-style-type: none"> <li>The unit is not on scheduled recording standby. (“⊖” on the unit’s display is not on.) Press [⊖ DVD POWER] to turn the unit off and make sure that “⊖” is on.</li> <li>The clock is not correct. Set the clock.</li> </ul>	8, 15 32, 47
The scheduled recording program remains even after recording finishes.	<ul style="list-style-type: none"> <li>The scheduled recording program remains if set to daily or weekly.</li> </ul>	8, 15
Part or all of a recording has been lost.	<ul style="list-style-type: none"> <li>If the power shuts down or the plug is disconnected from the household AC outlet while recording or editing, the program may be lost or the disc may become unusable. We cannot offer any guarantee regarding lost recordings or discs. You will have to format the disc (<b>RAM -RW(V) +RW</b>) or use a new disc.</li> </ul>	–
Stripe-shaped black noise is recorded.	<ul style="list-style-type: none"> <li>An external playback device is interfering with the TV because the device is too close to the TV. Move the device away from the TV.</li> </ul>	–
Cannot record video or sound from the external device.	<ul style="list-style-type: none"> <li>The external device is not correctly connected.</li> </ul>	22, 23
	<ul style="list-style-type: none"> <li>The proper external input channel (IN1, IN2, or DV) is not selected. Press [INPUT SELECT] to change.</li> </ul>	22
The DV Camcorder recording function does not work.	<ul style="list-style-type: none"> <li>If images cannot be recorded or if the recording is aborted, check the connections and the DV equipment settings.</li> </ul>	23
	<ul style="list-style-type: none"> <li>You cannot start recording until the images from the DV equipment appear on the television.</li> </ul>	–
	<ul style="list-style-type: none"> <li>Recording may not be performed as desired if the time codes on the tape in the DV equipment are not successive.</li> </ul>	–
	<ul style="list-style-type: none"> <li>Depending on the equipment, the DV Camcorder recording may not operate properly.</li> </ul>	–
	<ul style="list-style-type: none"> <li>You can only record audio/video images on a DV tape.</li> </ul>	–

Editing Issues	DVD	Page
Cannot format.	<ul style="list-style-type: none"> <li>The disc is dirty. Wipe with a damp cloth and then wipe dry.</li> </ul>	53
	<ul style="list-style-type: none"> <li>Disc may be defective or of poor quality.</li> </ul>	–
	<ul style="list-style-type: none"> <li>You tried formatting a disc that is not compatible with the unit.</li> </ul>	28
	<ul style="list-style-type: none"> <li><b>+RW</b> Discs created on a computer may not be formatted.</li> </ul>	–
Cannot create chapters.	<ul style="list-style-type: none"> <li>The unit writes the chapter division information to the disc when you turn it off or remove the disc. The information is not written if there is an interruption in the power.</li> </ul>	–
	<ul style="list-style-type: none"> <li>These operations are not possible with still pictures.</li> </ul>	–
Cannot delete chapters.	<ul style="list-style-type: none"> <li>When the chapter is too short to delete, use “Combine Chapters” to make the chapter longer <b>RAM</b>.</li> </ul>	26
The available recording time doesn’t increase even after deleting recordings on the disc.	<ul style="list-style-type: none"> <li>Available space on DVD-R, DVD-R DL, +R, or +R DL does not increase even after deleting previous recordings.</li> </ul>	–
	<ul style="list-style-type: none"> <li>Available space on DVD-RW (DVD-Video format) or +RW increases when you delete the last recording.</li> </ul>	–

# Frequently Asked Questions

Setup		Page
Do I need to connect Audio/video cables from the unit to the TV?	<ul style="list-style-type: none"> <li>To enjoy vision and sounds from this unit to the TV, always use audio/video (AV) cables for connection. If your television does not have AUDIO/VIDEO terminals, an RF modulator is necessary. Consult your local dealer for more information.</li> </ul>	38 to 41
What equipment is necessary to play multi-channel surround sound?	<ul style="list-style-type: none"> <li>You cannot play back multi-channel sound on this unit without other equipment. You must connect this unit with an optical digital audio cable to an amplifier with a built-in Dolby Digital or DTS decoder.</li> </ul>	43
Can the headphones and speakers be directly connected to the unit?	<ul style="list-style-type: none"> <li>You cannot directly connect to the unit. Connect through the amplifier, TV, etc.</li> </ul>	–
The television has an S-VIDEO IN terminal and COMPONENT VIDEO IN terminals. Which should I connect with?	<ul style="list-style-type: none"> <li>The output picture quality increases in the following order: VIDEO IN terminal → S-VIDEO IN terminal → COMPONENT VIDEO IN terminals.</li> </ul>	–
Is my TV progressive output compatible?	<ul style="list-style-type: none"> <li>All Panasonic TVs that have 480p input terminals are compatible. Consult the manufacturer if you have another brand of TV.</li> </ul>	–

Discs		Page
Can I play DVD-Video bought in another country?	<ul style="list-style-type: none"> <li>You can play them if the video standard is NTSC.</li> <li>However, you cannot play DVD-Video if its region number does not include “1” or “ALL”.</li> </ul>	– Cover
Can a DVD-Video that does not have a region number be played?	<ul style="list-style-type: none"> <li>Discs either without region number or region number “1” or “All” will not play on this unit.</li> </ul>	–
What are the constraints regarding DVD-R, DVD-R DL, DVD-RW, +R, +R DL, and +RW compatibility with the unit?	<ul style="list-style-type: none"> <li>The unit records and plays DVD-R, DVD-R DL, DVD-RW (DVD-Video format), +R, +R DL, and +RW, and plays DVD-RW (DVD Video Recording format).</li> </ul>	52, 53
	<ul style="list-style-type: none"> <li>The unit also records and plays high speed recording compatible discs.</li> </ul>	65
	<ul style="list-style-type: none"> <li>After recording but before finalizing these discs (except +RW disc):                             <ul style="list-style-type: none"> <li>– You may not be able to play and record discs on this unit after recording them on other Panasonic products or other manufacturer’s equipment.</li> <li>– You may not be able to play and record discs on other equipment after recording them on this unit.</li> </ul>                             After finalizing the disc, however, you will be able to play it on any DVD-Video compatible player.                         </li> </ul>	–
What are the constraints regarding CD-R and CD-RW compatibility with the unit?	<ul style="list-style-type: none"> <li>This unit plays CD-R/CD-RW discs which have been recorded in one of the following standards: CD-DA, MP3, and still pictures (JPEG). Close the session or finalize the disc after recording. This unit can recognize up to 99 folders (groups) and 999 files (tracks) on a disc with MP3 or still pictures (JPEG).</li> </ul>	53, 54
	<ul style="list-style-type: none"> <li>You cannot write to a CD-R or CD-RW with the unit.</li> </ul>	–

# Frequently Asked Questions

Recording		Page
Can I record from a commercially purchased video cassette or DVD?	<ul style="list-style-type: none"> <li>• Most commercially sold video cassettes and DVDs are copy protected; therefore, recording is usually not possible.</li> </ul>	–
Can DVD-R, DVD-R DL, DVD-RW (DVD-Video format), +R, +R DL, and +RW recorded on the unit be played on other equipment?	<ul style="list-style-type: none"> <li>• You can play these discs on compatible equipment such as DVD players after finalizing the disc on this unit.</li> </ul>	29
	<ul style="list-style-type: none"> <li>• <b>+RW</b> It is not necessary to finalize +RW. To enable play on other DVD players, please use “Create DVD Top Menu” in the DVD Management menu.</li> <li>• In any case, ability to play a disc depends on the condition of the recording, the quality of the disc, and the capability and format constraints of the DVD player.</li> </ul>	–
Can I record digital audio signals using the unit?	<ul style="list-style-type: none"> <li>• You cannot record digital signals. The digital audio terminals on the unit are for output only. (The audio recorded from a digital video camcorder using the DV automatic recording function, however, is recorded digitally.)</li> </ul>	–
Can a digital audio signal from the unit be recorded to other equipment?	<ul style="list-style-type: none"> <li>• You can record if using the PCM signal. When recording DVD, change the “Digital Audio Output” settings to the following via the Setup menu:               <ul style="list-style-type: none"> <li>– PCM Down Conversion: “On”</li> <li>– Dolby Digital: “PCM”</li> <li>– DTS: “PCM”</li> </ul>               However, only               <ul style="list-style-type: none"> <li>– As long as digital recording from the disc is permitted.</li> <li>– As long as the recording equipment is compatible with 48 kHz sampling frequency.</li> </ul> </li> </ul>	34
	<ul style="list-style-type: none"> <li>• You cannot record MP3 signals.</li> </ul>	–
Can I switch to SAP during recording?	<ul style="list-style-type: none"> <li>• With DVD-RAM, you can, and the audio recorded also changes. Press [AUDIO] to change to SAP.</li> </ul>	12
	<ul style="list-style-type: none"> <li>• You cannot change the audio type when recording an analog MTS broadcast on a DVD-R, DVD-R DL, DVD-RW (DVD-Video format), +R, +R DL or +RW disc. Establish the appropriate setting before recording with “Multi-channel TV Sound (Analog)” in the Setup menu.</li> </ul>	10, 12
	<ul style="list-style-type: none"> <li>• Only one language channel is recorded from digital MTS broadcasts, so you will be unable to change languages during recording. Set the language in “Audio Language Setting” in the Setup menus.</li> </ul>	10, 12

# Error Messages

On the Unit's Display		Page
H□□, F□□ (“□” stands for a service number.)	<ul style="list-style-type: none"> <li>An error has occurred. The number following “H” or “F” depends on the status of the unit. Check the items below and in the Troubleshooting Guide. If the service number still does not disappear after the check, reset the unit (→ 55, “To restore the unit if it freezes”).</li> <li>If the service numbers fail to clear, note the service numbers and contact a qualified service person.</li> </ul>	–
RC □ (“□” stands for a number.)	<ul style="list-style-type: none"> <li>The remote control and main unit are using different codes. Change the code on the remote control.</li> </ul>	55
HARD ERR (“HARd” and “Err” are alternately displayed.)	<ul style="list-style-type: none"> <li>If there is no change after turning the unit on and off, consult the dealer where the unit was purchased.</li> </ul>	–
NO READ (“NO” and “REAd” are alternately displayed.)	<ul style="list-style-type: none"> <li>The disc is dirty or badly scratched. The unit cannot record, play, or edit.</li> <li>The disc may be incompatible or of poor quality.</li> <li>You have used a lens cleaner and it has finished operation. Press [▲ OPEN/CLOSE] on the main unit to eject the disc.</li> </ul>	53 53 3
□□□□□□	<ul style="list-style-type: none"> <li>Displayed when the unit is started. This is not a malfunction.</li> <li>The unit is carrying out its recovery process. You cannot operate the unit while “□” is displayed.</li> </ul>	– –
FULL	<ul style="list-style-type: none"> <li>There are already 16 scheduled recording programs. Delete unnecessary scheduled recording programs.</li> </ul>	15
UNSUPPORT (“UNSUP” and “POrt” are alternately displayed.)	<ul style="list-style-type: none"> <li>You have inserted a disc the unit cannot play or record on.</li> </ul>	53
UNFORMAT (“UNFOr” and “MAT” are alternately displayed.)	<ul style="list-style-type: none"> <li>You have inserted a new DVD-RW/+RW or a DVD-RAM/DVD-RW (DVD-Video format) recorded on other equipment. You can format the disc when the format confirmation screen is displayed.</li> </ul>	28
U59	<ul style="list-style-type: none"> <li>The unit is very warm. The unit switches to standby for safety reasons. Wait for about 30 minutes until the message disappears. Reinstall the unit in an area with adequate ventilation. Do not block the cooling fan on the rear of the unit.</li> </ul>	–
U61	<ul style="list-style-type: none"> <li>There was a power failure or the AC power supply cord was disconnected while the unit was on. The unit is carrying out its recovery process. This process restores the unit to normal operation. The unit is not broken. Wait until the message disappears.</li> </ul>	–
U88	<ul style="list-style-type: none"> <li>There was something unusual detected with the disc while recording, playing; there was a power failure or the AC power supply cord was disconnected while the unit was on. The unit is carrying out its recovery process. This process restores the unit to normal operation. The unit is not broken. Wait until the message disappears.</li> </ul>	57
U99	<ul style="list-style-type: none"> <li>The unit fails to operate properly. Press [POWER ⏻/I] on the main unit to switch the unit to standby. Press [POWER ⏻/I] on the main unit again to turn the unit on.</li> </ul>	–

# Error Messages

On the TV		Page
Cannot finish recording completely.	<ul style="list-style-type: none"> <li>The program was copy-protected.</li> <li>The disc may be full.</li> <li>There are already 99 recordings (<b>+R +R DL +RW</b> 49 recordings).</li> </ul>	–
Cannot play.	<ul style="list-style-type: none"> <li>You inserted an incompatible disc (discs recorded in PAL video, etc.).</li> </ul>	–
Cannot record on the disc.	<ul style="list-style-type: none"> <li>The disc may be dirty or scratched.</li> </ul>	53
Unable to format.		
Please check the disc.		
Cannot record. Disc is full.	<ul style="list-style-type: none"> <li><b>RAM -RW(V) +RW</b> Create space by erasing unwanted recordings. Even if you erase recorded content from the DVD-R, DVD-R DL, +R or +R DL, there is no increase in disc space. Available recording space on a DVD-RW (DVD-Video format) or +RW disc increases when the last recording is deleted (space may increase slightly when you delete other recordings).</li> <li>Use a new disc.</li> </ul>	9, 24, 28
Cannot record. The number of recordings has exceeded the maximum limit.		
Error has occurred. Please press ENTER.	<ul style="list-style-type: none"> <li>Press [ENTER] to start the recovery process. You cannot operate the unit while it is recovering (“□ □ □ □ □” (Self Check) appears on the unit’s display).</li> </ul>	–
No disc.	<ul style="list-style-type: none"> <li>You haven’t inserted a disc. Correctly insert a disc that the unit can play.</li> <li>The disc is upside down. If it is a single-sided disc, insert it so the label is facing up.</li> </ul>	52, 53
		53
Please change the disc.	<ul style="list-style-type: none"> <li>There may be a problem with the disc. Press [<b>▲</b> OPEN/CLOSE] on the main unit to remove the disc to check for scratches and dirt. (The unit turns off automatically after you open the tray.)</li> </ul>	–
Please set the clock.	<ul style="list-style-type: none"> <li>The clock is not set when recording programs or setting scheduled recording. Set the clock.</li> </ul>	32, 47
This is a non-recordable disc.	<ul style="list-style-type: none"> <li>The unit cannot record on the disc you inserted. Insert a DVD-RAM or unfinalized DVD-R, DVD-R DL, DVD-RW (DVD-Video format), +R, +R DL, or +RW disc.</li> <li>The disc may be incompatible or of poor quality.</li> </ul>	52
		53
This disc is not formatted properly.	<ul style="list-style-type: none"> <li>You inserted an unformatted DVD-RAM, DVD-RW, or +RW disc. Format the disc with the unit.</li> </ul>	28
⊙	<ul style="list-style-type: none"> <li>The operation is prohibited by the unit or disc.</li> </ul>	–

## Product Service

- Damage requiring service**—The unit should be serviced by qualified service personnel if:
  - The AC power supply cord or AC adaptor has been damaged; or
  - Objects or liquids have gotten into the unit; or
  - The unit has been exposed to rain; or
  - The unit does not operate normally or exhibits a marked change in performance; or
  - The unit has been dropped or the cabinet damaged.
- Servicing**—Do not attempt to service the unit beyond that described in these operating instructions. Refer all other servicing to authorized servicing personnel.

- Replacement parts**—When parts need replacing ensure the servicer uses parts specified by the manufacturer or parts that have the same characteristics as the original parts. Unauthorized substitutes may result in fire, electric shock, or other hazards.
- Safety check**—After repairs or service, ask the servicer to perform safety checks to confirm that the unit is in proper working condition.

### Product information

For product information or assistance with product operation:  
Refer to “Customer Services Directory” on page 67.



# Specifications

Power supply:	AC 120 V, 60 Hz
Power consumption:	Approx. 24 W
Standby mode: (Shipping Condition)	Approx. 2.4 W
(User Setting: Quick Start: ON):	Approx. 14.1 W

## Recordable discs:

DVD-RAM:	2X SPEED (Ver. 2.0)
	2-3X SPEED (Ver. 2.1)
	2-5X SPEED (Ver. 2.2)
DVD-R(SL):	1X SPEED (Ver. 2.0)
	1-4X SPEED (Ver. 2.0)
	1-8X SPEED (Ver. 2.0)
	1-16X SPEED (Ver. 2.1)
DVD-R(DL):	2-4X SPEED (Ver. 3.0)
	2-8X SPEED (Ver. 3.0)
DVD-RW:	1X SPEED (Ver. 1.1)
	1-2X SPEED (Ver. 1.1)
	2-4X SPEED (Ver. 1.2)
	2-6X SPEED (Ver. 1.2)
+R(SL):	2.4X SPEED (Ver. 1.0)
	2.4-4X SPEED (Ver. 1.1)
	2.4-8X SPEED (Ver. 1.2)
	2.4-16X SPEED (Ver. 1.3)
+R(DL):	2.4X SPEED (Ver. 1.0)
	2.4-8X SPEED (Ver. 1.1)
+RW:	2.4X SPEED (Ver. 1.1)
	2.4-4X SPEED (Ver. 1.2)

## Recording system:

DVD-RAM:	DVD Video Recording format
DVD-R:	DVD-Video format
DVD-R DL (Dual Layer):	DVD-Video format
DVD-RW:	DVD-Video format
+R	
+R DL (Double Layer)	
+RW	

## Recording time:

Max. 8 hours (using 4.7 GB disc)	
XP: Approx. 1 hour	SP: Approx. 2 hours
LP: Approx. 4 hours	EP: Approx. 6 hours or 8 hours

## Playable discs:

DVD-RAM:	DVD Video Recording format
DVD-R:	DVD-Video format
DVD-R DL (Dual Layer):	DVD-Video format
DVD-RW:	DVD-Video format, DVD Video Recording format
+R	
+R DL (Double Layer)	
+RW	
	DVD-Video, CD-Audio (CD-DA)
	CD-R/CD-RW (CD-DA, MP3, JPEG)

## Optical pick-up:

System with 1 lens, 2 integration units  
(662 nm wavelength for DVDs, 780 nm wavelength for CDs)

## LASER Specification:

Class I LASER Product	
Wave Length:	780 nm (CDs)
	662 nm (DVDs)
Laser Power:	No hazardous radiation is emitted with the safety protection

## Television system:

TV system:	NTSC system, 525 lines, 60 fields
Antenna reception input:	Analog TV Channel: 2 to 69 ch
	Analog CATV Channel: 1 to 135 ch
	Digital TV Channel: 2 to 69 ch
	Digital CATV Channel: 1 to 135 ch
RF converter output:	Not provided

## Quick Start for Recording (Quick Start : ON):

1 Sec. Quick Start for Recording on DVD-RAM\*

\*From the power off state, recording on DVD-RAM starts about 1 second after first pressing the Power button and then sequentially pressing the REC button (Quick Start Mode).

## Video system:

### Recording system:

Input:	MPEG2 (Hybrid VBR)	
	LINE (pin jack) ×2	1.0 Vp-p; 75 Ω
	S connector ×2	Y: 1.0 Vp-p; 75 Ω
		C: 0.286 Vp-p; 75 Ω
Output:	LINE (pin jack) ×1	1.0 Vp-p; 75 Ω
	S connector ×1	Y: 1.0 Vp-p; 75 Ω
		C: 0.286 Vp-p; 75 Ω
Component video output:		
	Y, Pb, Pr ×1	Y: 1.0 Vp-p; 75 Ω
	(480i/480p)	Pb: 0.7 Vp-p; 75 Ω
		Pr: 0.7 Vp-p; 75 Ω

## Audio system:

### Recording system:

Analog Input:	Dolby Digital (2 ch)
	LINE (pin jack) ×2
	Reference input: 309 mVrms
	FS: 2 Vrms (1 kHz, 0 dB)
	Input impedance: 47 kΩ
Analog Output:	LINE (pin jack) ×1
	Reference output: 309 mVrms
	FS: 2 Vrms (1 kHz, 0 dB)
	Output impedance: 1 kΩ
	(Load impedance: 10 kΩ)

### Number of channels:

Recording: 2 channels  
Playback: 2 channels

Digital Output: Digital audio optical output connector ×1  
(PCM, Dolby Digital, DTS)

DV Input: IEEE 1394 Standard, 4 Pin ×1

Regional Code: # 1

Clock unit: Quartz-controlled 12-hour digital display

### Operating temperature range:

5 °C to 40 °C (41 °F to 104 °F)

### Operating humidity range:

10 % to 80 % RH (no condensation)

Dimensions: 430 mm (W) × 59 mm (H) × 252 mm (D)  
[16 15/16" (W) × 2 3/8" (H) × 9 15/16" (D)]

Mass: Approx. 2.8 kg (Approx. 6.16 lbs)



## Notes

Specifications are subject to change without notice.

# Glossary

## Bitstream

This is a signal compressed and converted into digital form. It is converted back to a multi-channel audio signal, e.g., 5.1-channel, by a decoder.

## CPRM (Content Protection for Recordable Media)

CPRM is technology used to protect broadcasts that are allowed to be recorded only once. Such broadcasts can be recorded only with CPRM-compatible recorders and discs.

## Decoder

A decoder restores the coded audio signals on DVDs to normal. This is called decoding.

## Dolby Digital

This is a method of coding digital signals developed by Dolby Laboratories. Apart from stereo (2-channel) audio, these signals can also be multi-channel audio. A large amount of audio information can be recorded on one disc using this method.

## Down-mixing

This is the process of remixing the multi-channel audio found on some discs into two channels. It is useful when you want to listen to the 5.1-channel audio recorded on DVDs through your TV's speakers. Some discs prohibit down-mixing. If this is the case, this unit can only output the front two channels.

## DTS (Digital Theater Systems)

This surround system is used in many movie theaters. There is good separation between the channels, so realistic sound effects are possible.

## Dynamic range

Dynamic range is the difference between the lowest level of sound that can be heard above the noise of the equipment and the highest level of sound before distortion occurs. Dynamic range compression means reducing the gap between the loudest and softest sounds. This means you can hear dialog clearly at low volume.

## Film and Video

DVD-Video are recorded using either film or video. The unit can determine which type has been used, then uses the most suitable method of progressive output.

Film is 24 or 30 frames per second, with motion picture film generally being 24 frames per second.

Video is 60 fields per second (2 fields making up 1 frame).

## Finalize

A process that makes play of a recorded CD-R, CD-RW, DVD-R, etc. possible on equipment that can play such media. You can finalize DVD-R, DVD-R DL, DVD-RW (DVD-Video format), +R, and +R DL on the unit. After finalizing, the disc becomes play-only and you can no longer record or edit. However, finalized DVD-RW can be formatted to become recordable.

## Formatting

Formatting is the process of making media such as DVD-RAM recordable on recording equipment.

You can format DVD-RAM, DVD-RW (only as DVD-Video format) and +RW on this unit.

Formatting irrevocably erases all contents.

## Frame and field

Frame refers to the single images that constitute the video you see on your TV. Each frame consists of 2 fields.



Frame

Field

Field

- A frame still shows 2 fields, so there may be some blurring between them, but picture quality is generally better.
- A field still shows less picture information so it may be rougher, but there is no blurring.

## JPEG (Joint Photographic Experts Group)

This is a system used for compressing/decoding color still pictures. If you select JPEG as the storage system on digital cameras, etc., the data will be compressed to 1/10-1/100 of its original size. The benefit of JPEG is less deterioration in picture quality considering the degree of compression.

## MP3 (MPEG Audio Layer 3)

An audio compression method that compresses audio to approximately one-tenth of its size without any significant loss of audio quality. You can play MP3s you have recorded onto CD-R and CD-RW.

## Pan & Scan/Letterbox

In general, DVD-Video are produced with the intention that they will be viewed on a widescreen TV (16:9 aspect ratio), so images often don't fit regular TVs (4:3 aspect ratio). 2 styles of picture, "Pan & Scan" and "Letterbox", deal with this problem.

Pan & Scan: The sides are cut off so the picture fills the screen.



Letterbox: Black bands appear at the top and bottom of the picture so the picture itself appears in an aspect ratio of 16:9.



## Progressive/Interlace

NTSC, the video signal standard, has 480 interlaced (i) scan lines, whereas progressive scanning uses twice the number of scan lines. This is called 480p.

Using progressive output, you can enjoy the high-resolution video recorded on media such as DVD-Video.

Your TV must be compatible to enjoy progressive video.

## Protection

You can prevent accidental erasure by setting writing protection or erasure protection.

## Sampling frequency

Sampling is the process of converting the heights of sound wave (analog signal) samples taken at set periods into digits (digital encoding). Sampling frequency is the number of samples taken per second, so larger numbers mean more faithful reproduction of the original sound.

## Thumbnail

This refers to a miniature representation of a picture used to display multiple pictures in the form of a matrix.

The model number and serial number of this product can be found on either the back or the bottom of the unit.

Please note them in the space provided below and keep for future reference.

MODEL NUMBER

DMR-EZ17

SERIAL NUMBER

User memo:

DATE OF PURCHASE

DEALER NAME

DEALER ADDRESS

TELEPHONE NUMBER

# Limited Warranty

Panasonic Consumer Electronics Company,  
Division of Panasonic Corporation of North America  
One Panasonic Way Secaucus, New Jersey 07094

Panasonic Puerto Rico, Inc.  
Ave. 65 de Infantería, Km. 9.5  
San Gabriel Industrial Park, Carolina, Puerto Rico 00985

## Panasonic DVD Recorder Limited Warranty

### Limited Warranty Coverage

If your product does not work properly because of a defect in materials or workmanship, Panasonic Consumer Electronics Company or Panasonic Puerto Rico, Inc. (collectively referred to as "the warrantor") will, for the length of the period indicated on the chart below, which starts with the date of original purchase ("warranty period"), at its option either (a) repair your product with new or refurbished parts, or (b) replace it with a new or a refurbished product. The decision to repair or replace will be made by the warrantor.

Product or Part Name	Parts	Labor
DVD Recorder	One (1) Year	One (1) Year
Rechargeable Batteries, DVD-RAM Disc (in exchange for defective item)	Ten (10) Days	Not Applicable

During the "Labor" warranty period there will be no charge for labor. During the "Parts" warranty period, there will be no charge for parts. You must carry-in or mail-in your product during the warranty period. If non-rechargeable batteries are included, they are not warranted. This warranty only applies to products purchased and serviced in the United States or Puerto Rico. This warranty is extended only to the original purchaser of a new product which was not sold "as is". A purchase receipt or other proof of the original purchase date is required for warranty service.

### Carry-In or Mail-In Service

For Carry-In or Mail-In Service in the United States call 1-800-211-PANA (7262) or visit Panasonic Web Site: <http://www.panasonic.com>

For assistance in Puerto Rico call Panasonic Puerto Rico, Inc. (787)-750-4300 or fax (787)-768-2910.

### Limited Warranty Limits And Exclusions

This warranty ONLY COVERS failures due to defects in materials or workmanship, and DOES NOT COVER normal wear and tear or cosmetic damage. The warranty ALSO DOES NOT COVER damages which occurred in shipment, or failures which are caused by products not supplied by the warrantor, or failures which result from accidents, misuse, abuse, neglect, mishandling, misapplication, alteration, faulty installation, set-up adjustments, misadjustment of consumer controls, improper maintenance, power line surge, lightning damage, modification, or commercial use (such as in a hotel, office, restaurant, or other business), rental use of the product, service by anyone other than a Factory Servicenter or other Authorized Servicer, or damage that is attributable to acts of God.

**THERE ARE NO EXPRESS WARRANTIES EXCEPT AS LISTED UNDER "LIMITED WARRANTY COVERAGE". THE WARRANTOR IS NOT LIABLE FOR INCIDENTAL OR CONSEQUENTIAL DAMAGES RESULTING FROM THE USE OF THIS PRODUCT, OR ARISING OUT OF ANY BREACH OF THIS WARRANTY.** (As examples, this excludes damages for lost time, travel to and from the servicer, loss of media or images, data or other recorded content. The items listed are not exclusive, but are for illustration only.) **ALL EXPRESS AND IMPLIED WARRANTIES, INCLUDING THE WARRANTY OF MERCHANTABILITY, ARE LIMITED TO THE PERIOD OF THE LIMITED WARRANTY.**

Some states do not allow the exclusion or limitation of incidental or consequential damages, or limitations on how long an implied warranty lasts, so the exclusions may not apply to you.

This warranty gives you specific legal rights and you may also have other rights which vary from state to state. If a problem with this product develops during or after the warranty period, you may contact your dealer or Servicenter. If the problem is not handled to your satisfaction, then write to the warrantor's Consumer Affairs Department at the addresses listed for the warrantor.

**PARTS AND SERVICE WHICH ARE NOT COVERED BY THIS LIMITED WARRANTY ARE YOUR RESPONSIBILITY.**

## Customer Services Directory

Obtain Product Information and Operating Assistance; locate your nearest Dealer or Servicenter; purchase Parts and Accessories; or make Customer Service and Literature requests by visiting our Web Site at:

<http://www.panasonic.com/consumersupport>

or, contact us via the web at:

<http://www.panasonic.com/contactinfo>

You may also contact us directly at:

1-800-211-PANA (7262),

Monday-Friday 9 am-9 pm; Saturday-Sunday 10 am-7 pm, EST.

For hearing or speech impaired TTY users, TTY: 1-877-833-8855

## Accessory Purchases

Purchase Parts, Accessories and Instruction Books online for all Panasonic Products by visiting our Web Site at:

<http://www.pstc.panasonic.com>

or, send your request by E-mail to:

[npcparts@us.panasonic.com](mailto:npcparts@us.panasonic.com)

You may also contact us directly at:

1-800-332-5368 (Phone) 1-800-237-9080 (Fax Only) (Monday – Friday 9 am to 8 pm, EST.)

Panasonic Service and Technology Company

20421 84th Avenue South, Kent, WA 98032

(We Accept Visa, MasterCard, Discover Card, American Express, and Personal Checks)

For hearing or speech impaired TTY users, TTY: 1-866-605-1277

## Service in Puerto Rico

Panasonic Puerto Rico, Inc.

Ave. 65 de Infantería, Km. 9.5, San Gabriel Industrial Park, Carolina, Puerto Rico 00985

Phone (787)750-4300, Fax (787)768-2910

# Referencia rápida en español (Spanish Quick Reference)

## Conexión básica

**Nota:** Puede que los terminales en el panel trasero de su TV no sean similares a como se ilustran a continuación. Por favor consulte las etiquetas de los terminales con atención para asegurar conexiones correctas.

Conexión a una televisión o videograbadora (dispositivo que NO sea de recepción de señal de cable ni satelital)

- Se requiere cable coaxial y cable de audio/vídeo adicionales.

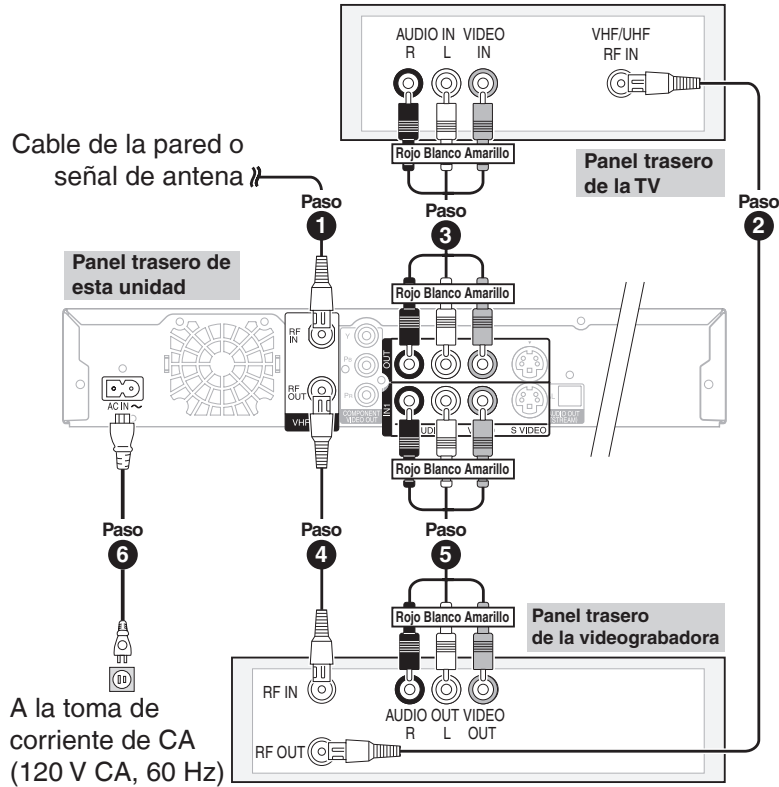

### Uso del modulador RF en el caso de que su televisión carezca de terminales de audio/vídeo

- Conecte los cables en el paso 2 y paso 3 (como se menciona anteriormente) como se indica a continuación.

Cable de la pared o señal de antena

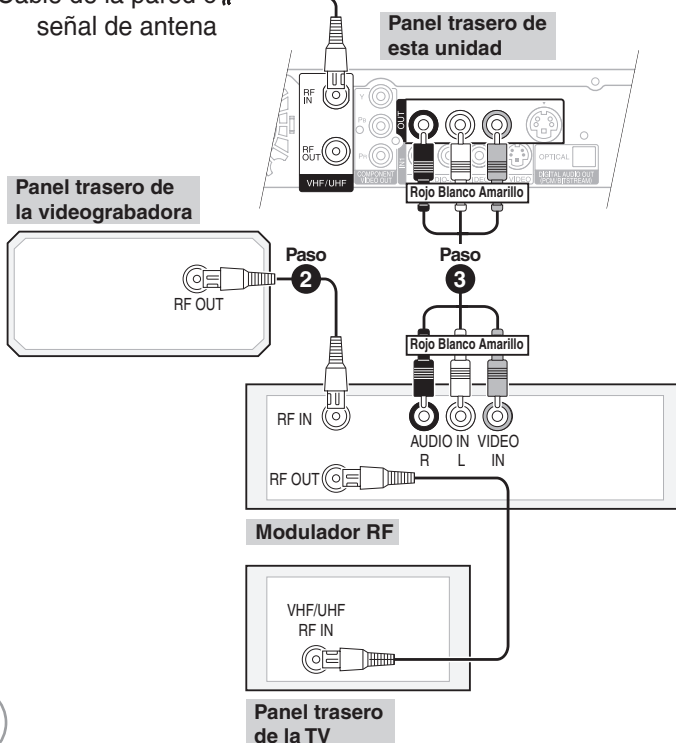

### Para disfrutar de una mejor calidad de imagen

- La terminal S VIDEO OUT logra una imagen más viva que la del terminal VIDEO OUT (los resultados reales dependen de la televisión).
- Los terminales COMPONENT VIDEO OUT en esta unidad se pueden utilizar para la salida entrelazada o progresiva, para proporcionar una imagen más pura que la del terminal S VIDEO OUT.

## Ajuste de los canales y el reloj

### Preparación:

Encienda la televisión y seleccione la entrada de video apropiada a las conexiones de esta unidad.

**1**  para encender la unidad.

**2** ▲, ▼ para seleccionar el idioma, y luego 

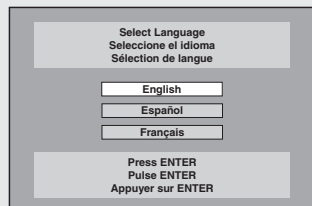

**3** ▲, ▼ para seleccionar la relación de aspecto “TV de 4:3” o “TV ancho de 16:9” y luego 

- Al conectar a una TV con relación de aspecto 4:3: seleccione “TV de 4:3”.
- Al conectar a una TV con pantalla panorámica 16:9: seleccione “TV ancho de 16:9”.

**4** ▲, ▼ para seleccionar la función de inicio rápido “Act.” o “Desactivado”, luego 

**5** ▲, ▼ para seleccionar si desea o no recibir señal de TV del terminal RF IN de la unidad, y luego 

- Cuando seleccione “No”, la unidad entonces mostrará la pantalla “Ajuste manual del reloj”. (→ derecha)

**6** ▲, ▼ para seleccionar “Antena” o “Cable”, luego 

**7**  para iniciar el ajuste automático de canales/reloj.

**8** Confirmar hora, luego 

- HL (horario de verano) muestra el ajuste para el verano.
- Huso h.(la zona horaria) muestra la diferencia de hora con la hora del Meridiano de Greenwich (GMT).

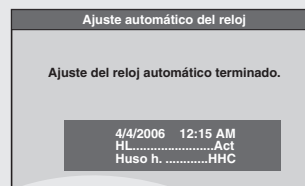

### Consejos prácticos

Si aparece la pantalla “Ajuste manual del reloj”.

1. Oprima [◀▶] para seleccionar la opción que desee modificar y oprima [▲,▼] para cambiar el ajuste.
2. Oprima [ENTER].

Se mostrará una pantalla con una imagen o con un fondo negro. El reloj se pone en funcionamiento.

# Referencia rápida en español (Spanish Quick Reference)

## Preparación:

- Encienda la televisión y seleccione la entrada de video apropiada a las conexiones de esta unidad.

## Selección de un canal

**1**  para encender la unidad.

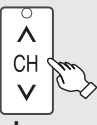
**2**  para seleccionar el canal deseado.

También puede seleccionar canales con los botones numéricos.

- **Para ingresar directamente los canales para emisiones análogas y digitales:**

Modo Antena:

Por ejemplo, "3": [0] → [3] → [ENTER]

"13": [1] → [3] → [ENTER]

Modo Cable TV:

Por ejemplo, "5": [0] → [0] → [5] → [ENTER]

"15": [0] → [1] → [5] → [ENTER]

- **Para ingresar el número menor de canal para una emisión digital:**

Modo Antena:

Por ejemplo, "3-1": [3] → [-] → [1] → [ENTER]

"13-1": [1] → [3] → [1] → [ENTER]

Modo Cable TV:

Por ejemplo, "1-1": [1] → [-] → [1] → [ENTER]

"15-1": [1] → [5] → [-] → [1] → [ENTER]

## Reproducción de discos

**RAM -R -R DL -RW(V) +R +R DL +RW DVD-V -RW(VR) CD**

**1**  para encender la unidad.

**2**  para abrir la bandeja  
(botón ubicado en el panel frontal de la unidad).  
– Inserte un disco.

**3**  – La bandeja se cierra y comienza la reproducción.

## Consejos prácticos

### Detener la reproducción

Oprima [■ STOP].

– La posición de detención se memoriza.

– La posición de detención se borra al oprimir [■ STOP] varias veces.

### Pausar la reproducción

Oprima [|| PAUSE].

– Oprima de nuevo para reiniciar la reproducción.

### Selección de grabaciones para reproducir

**RAM -R -R DL -RW(V) +R +R DL +RW -RW(VR)**

Realice los pasos 1 y 2 de "Reproducción de discos" (→ izquierda).

1. Oprima [DIRECT NAVIGATOR].

2. ▲, ▼, ◀, ▶ para seleccionar la grabación que desea ver, luego oprima [ENTER].

## Grabación de programas de televisión

**RAM -R -R DL -RW(V) +R +R DL +RW**

### Preparación:

- Encienda la televisión y seleccione la entrada de video apropiada a las conexiones de esta unidad.
- **RAM** Si el disco está protegido, libere la protección.

**1**  para encender la unidad.

**2**  para abrir la bandeja  
(botón ubicado en el frente de la unidad).

– Inserte un disco con suficiente espacio disponible y oprima el botón de nuevo para cerrar la bandeja.

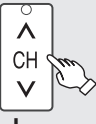
**3**  para seleccionar el canal deseado.

– Para seleccionar con los botones numéricos (→ izquierda)

**4**  para seleccionar el modo de grabación.

**5**  para comenzar a grabar.

## Consejos prácticos

### Pausar la grabación

Oprima [|| PAUSE].

– Oprima de nuevo para reiniciar la grabación.

### Detener la grabación

Oprima [■ STOP].

## Grabación programada

RAM -R -R DL -RW(V) +R +R DL +RW

### Preparación:

- Encienda la televisión y seleccione la entrada de video apropiada a las conexiones de esta unidad.
- **RAM** Si el disco está protegido, libere la protección.
- Inserte un disco con suficiente espacio disponible.
- Confirme que el reloj en el visualizador de la unidad está ajustado con la hora correcta.
- Si está conectado vía un receptor de señal de cable o satelital, ajuste el canal ahí antes de que inicie la grabación programada.

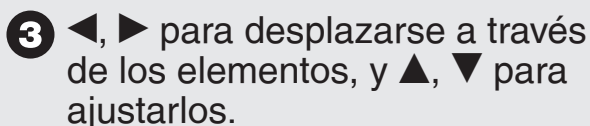
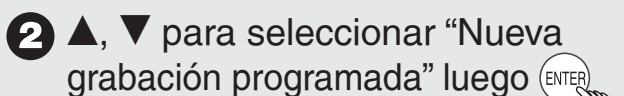

- Canal/Entrada – Estación de TV/Entrada externa
- Fecha/Frecuencia – Puede ajustar un programa diario o semanal.
- Act. (hora de inicio) / Des. (hora de finalización) – Mantenga el botón oprimido para cambiar en incrementos de 30 minutos.
- Modo – Modo de grabación
- Nombre – Oprima [ENTER], para ingresar el texto en la pantalla de nombre.

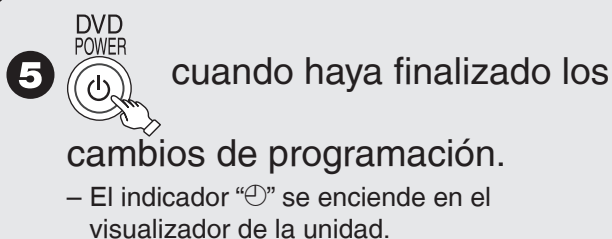
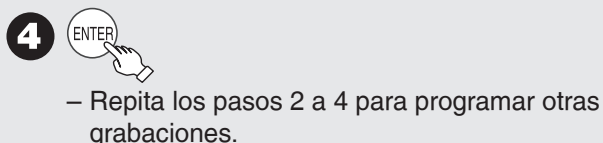
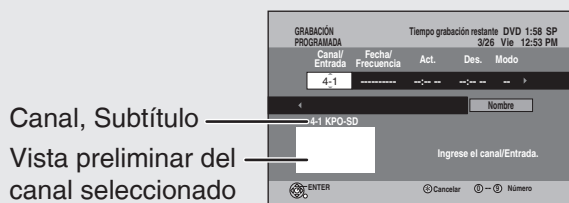

Importante: una vez borrados, los contenidos no podrán recuperarse.

## Borrado de grabaciones con el navegador de borrado (BORRAR Navegador)

RAM -R -R DL -RW(V) +R +R DL +RW

### Preparación:

- Encienda la televisión y seleccione la entrada de video apropiada a las conexiones de esta unidad.
- **RAM** Si el disco está protegido, libere la protección.
- Inserte un disco y oprima [▲ OPEN/CLOSE] de nuevo para cerrar la bandeja.

Con la unidad detenida

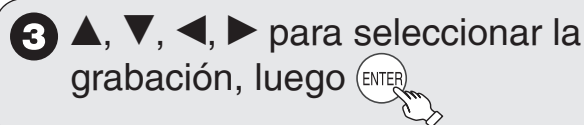
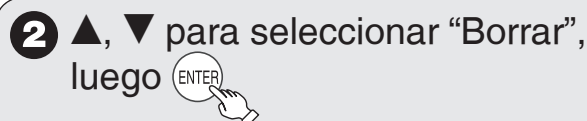

### Consejos prácticos

**Para volver a la pantalla anterior**

Oprima [RETURN].

**Para ver otras páginas**

Oprima [▲, ▼, ◀, ▶] para seleccionar “Atrás” o “Avanza” y oprima [ENTER].

- También puede oprimir [◀◀, ▶▶] para ver otras páginas.

**Edición múltiple**

Seleccione con [▲, ▼, ◀, ▶] y oprima [|| PAUSE]. (Repetir.)

- Aparece una marca de verificación. Oprima [|| PAUSE] de nuevo para cancelar.

## Borrar grabaciones durante la reproducción

RAM -R -R DL -RW(V) +R +R DL +RW

Durante la reproducción



# Index

<b>A</b> Angle.....	30	<b>E</b> Enter name		<b>P</b> Parental Rating .....	36, 37
<b>Audio</b>		disc .....	21, 27	<b>PCM Down Conversion .....</b>	34
attribute.....	30	recording.....	21, 24	<b>Picture .....</b>	31
language.....	33	<b>External Device.....</b>	22	<b>Playlist .....</b>	20
receiving, recording.....	12, 34	<b>F</b> Finalize .....	12, 29	<b>Progressive .....</b>	31, 66
<b>Audio Language Setting .....</b>	32	<b>Flexible Recording.....</b>	13	<b>Properties</b>	
<b>B</b> Change Thumbnail .....	25	Format disc .....	12, 28	playlist.....	20
<b>Channel</b>		<b>FR (Flexible Recording) Mode.....</b>	11	recording.....	24
adding, deleting .....	46	<b>FUNCTIONS window .....</b>	50	<b>Protection</b>	
audio.....	30	<b>J</b> JPEG .....	18, 54, 66	cartridge.....	27
captions .....	46	<b>L</b> Language		disc .....	27
Set Channels Automatically.....	32	audio.....	33	recording.....	25
<b>Chasing Playback.....</b>	14	code list.....	33	<b>Q</b> Quick Start .....	32
<b>Cleaning</b>		on-screen.....	34	<b>Quick View.....</b>	16
disc .....	53	soundtrack.....	30	<b>R</b> Ratings .....	33
lens .....	3	subtitle .....	30	<b>Record</b>	
main unit.....	3	<b>M</b> Menu		Flexible Recording.....	13
<b>Clock Settings.....</b>	47	MP3 .....	19	from a video cassette recorder .....	22
<b>Closed Caption .....</b>	35	on-screen.....	30	mode.....	11
<b>CM Skip .....</b>	17	Pictures.....	18	scheduled .....	8, 15
<b>Connection</b>		Setup .....	32	<b>Repeat play .....</b>	30
amplifier, system component .....	43	<b>Mode</b>		Restore Default Settings.....	32
antenna.....	38, 39, 40, 41, 55	recording.....	11	Resume play function .....	6
cable box.....	39	still mode.....	33	<b>S</b> Scheduled recording.....	8, 15
DV IN terminal .....	23	MP3 .....	19, 54, 66	Setup menu .....	32
satellite receiver.....	40	<b>N</b> Noise reduction (NR)		Signal Source (Antenna / RF IN) .....	32
television.....	38, 39, 40, 41, 42	DNR.....	31	Simultaneous rec and play .....	14
video cassette recorder .....	22, 42	Line-in NR.....	31	<b>Soundtrack.....</b>	30
<b>CPRM.....</b>	66	<b>O</b> On-screen		Status messages .....	21
<b>Create Chapter.....</b>	17, 26	language.....	34	Subtitle .....	30
<b>Create DVD Top Menu.....</b>	29	menus.....	30	<b>T</b> Thumbnail .....	66
<b>D</b> Delete		status messages.....	21	Time Slip.....	17
all recordings .....	28	<b>V</b> V. Surround Sound.....	31	Transfer .....	31
chapter.....	26			TV Type .....	46
recording.....	9, 24				
Delete Navigator .....	9				
Dialog Enhancer .....	31				
Direct Navigator.....	16, 18				
Divide Recording .....	25				
DNR.....	31				
DST .....	45, 47				
DV automatic recording .....	23				
DVD-RAM, DVD-R, DVD-R DL, DVD-RW,					
+R, +R DL, +RW.....	52				

Manufactured under license from Dolby Laboratories. Dolby and the double-D symbol are trademarks of Dolby Laboratories.

"DTS" is a registered trademark of DTS, Inc. and "DTS 2.0+Digital Out" is a trademark of DTS, Inc.

Apparatus Claims of U.S. Patent Nos. 4,631,603, 4,577,216, and 4,819,098, licensed for limited viewing uses only.

This product incorporates copyright protection technology that is protected by method claims of certain U.S. patents and other intellectual property rights owned by Macrovision Corporation and other rights owners. Use of this copyright protection technology must be authorized by Macrovision Corporation, and is intended for home and other limited viewing uses only unless otherwise authorized by Macrovision Corporation. Reverse engineering or disassembly is prohibited.

## -If you see this symbol-

### Information on Disposal in other Countries outside the European Union



This symbol is only valid in the European Union. If you wish to discard this product, please contact your local authorities or dealer and ask for the correct method of disposal.

**Panasonic Consumer Electronics Company, Division of Panasonic Corporation of North America**  
One Panasonic Way Secaucus, New Jersey 07094  
<http://www.panasonic.com>

**Panasonic Puerto Rico, Inc.**  
Ave. 65 de Infantería, Km. 9.5  
San Gabriel Industrial Park, Carolina,  
Puerto Rico 00985

En Sp

© 2006 Matsushita Electric Industrial Co., Ltd.  
Printed in China

RQT8850-1P  
H1206KY1027